

The background of the entire page is a close-up, high-angle photograph of a key cutting machine. The machine is dark-colored with various metallic components. A key is being cut by a rotating wheel, and several finished keys are visible in the foreground. The lighting is dramatic, highlighting the metallic surfaces and the precision of the machinery.

CAT. ESPECIALISTA
SPECIALIST'S GUIDE

CE.04

4 JMA es Compromiso
JMA Konpromisoa da
JMA is Commitment
JMA, l'engagement
JMA bedeutet Verpflichtung

5 Aviso legal
Mezu Legala
Legal Warning
Informations Légales
Rechtliche Hinweise

7 Índice
Aurkibidea
Index
Index
Verzeichnis

A1-A33 MÁQUINAS PARA LLAVES DE SEGURIDAD
SEGURTASUN-GILTZETARAKO MAKINAK
MACHINES FOR DIMPLE KEYS
MACHINES POUR CLES DE SECURITE
MASCHINEN FÜR BOHRMULDENSCHLÜSSEL

A1-A7 Máquinas
Makinak
Machines
Machines
Maschinen

A9-A30 Ficha Especialista
Giltzen fitxa teknikoa
Technical file keys
Fiche technique clés
Technisches Datenblatt Schlüssel

A31-A33 Llaves Originales
Jatorrizko giltzak
Original keys
Clé originales
Originalschlüssel

B1-B16 MÁQUINAS PARA LLAVES PLANAS
GILTZA LAUETARAKO MAKINAK
MACHINES FOR CYLINDER KEYS
MACHINES POUR CLE PLATES
MASCHINEN FÜR ZYLINDERSCHLÜSSEL

B1-B7 Máquinas
Makinak
Machines
Machines
Maschinen

B9-B14 Ficha Especialista
Giltzen fitxa teknikoa
Technical file keys
Fiche technique clés
Technisches Datenblatt Schlüssel

B15-B16 Llaves Originales
Jatorrizko giltzak
Original keys
Clé originales
Originalschlüssel

C1-C9 MÁQUINAS PARA LLAVES DE GORJA
GORJA-GILTZETARAKO MAKINAK
MACHINES FOR BIT KEYS
MACHINES POUR CLES A GORGES
MASCHINEN FÜR DOPPELBARTSCHLÜSSEL

C1-C5 Máquinas
Makinak
Machines
Machines
Maschinen

C7-C9 Ficha Especialista
Giltzen fitxa teknikoa
Technical file keys
Fiche technique clés
Technisches Datenblatt Schlüssel

**NUESTRO ÉXITO ESTÁ BASADO EN
EL COMPROMISO DE LAS PERSONAS**

Alejandro Altuna S.L.U. es la sociedad matriz e impulsora de Altuna Group. Fabrica todo tipo de llaves para cerradura así como máquinas duplicadoras. Sus productos van destinados al mercado OEM y a la reposición, en este caso con la marca JMA.

Fundada por el Sr. Alejandro Altuna en 1942 arrancó su actividad en Mondragón. Posteriormente, la estrategia de apertura de mercados exteriores apoyada en la internacionalización y siempre basada en un enfoque innovador de los procesos industriales, ha convertido a ALTUNA GROUP en el primer productor de llaves europeo y referente mundial en este campo.

Actualmente, 15 compañías en 4 continentes trabajan conjuntamente para el desarrollo y potenciación de la fuerza de nuestra marca JMA, conocida en más de 100 países en todo el mundo.

JMA integra equipos de personas comprometidas y motivadas por un proyecto común que nos ha permitido ser el mayor fabricante de llaves de Europa.

**OUR SUCCESS IS BASED ON
OUR PEOPLE'S COMMITMENT**

Alejandro Altuna S.L.U. is the parent company and driving force behind the Altuna Group. It manufactures all types of lock-keys and key-cutting machines. Its products are for the OEM and replacement markets, in the latter case with the JMA brand.

Set up by Alejandro Altuna in 1942, it started the production in Mondragón (Spain). Later, the strategy of opening up to foreign markets backed by globalisation and always based on an innovative attitude towards industrial processes, turned the ALTUNA GROUP into the largest producer of keys in Europe and a benchmark worldwide in the field.

Currently 15 companies in four continents work together to develop the strength of our JMA brand, well known in more than 100 countries all over the world.

This successful trail that leded us to be the biggest key producer in Europe is based in our people's commitment to be:

LIDER EN TECNOLOGÍA:

Una apuesta sólida por la calidad y la innovación basada en la automatización y garantía de procesos y soportada por una vocación inversora a largo plazo.

**LIDER EN CALIDAD:**

Nuestra política de calidad se basa en la prevención y planificación, mejora continua, satisfacción del cliente y participación de las personas. Además de la Certificación en Calidad de acuerdo a la ISO 9001, Alejandro Altuna S.L.U. acoge Sistemas de Gestión de la Calidad homologados por las empresas líderes del sector de automoción y residencial.

**LIDER EN EL COMPROMISO
POR EL MEDIO AMBIENTE:**

En Alejandro Altuna S.L.U. las buenas prácticas medioambientales son la norma y no la excepción. Nuestro equipo forma parte de un proyecto de empresa respetuoso con el medioambiente y que colabora con el desarrollo sostenible de nuestro entorno. Alejandro Altuna S.L.U. fue el primer fabricante mundial de llaves en conseguir en 2000 el certificado ISO 14001 para su Sistema de Gestión.

**LIDER EN SERVICIO:**

La realidad de una empresa se demuestra en su capacidad por responder con la máxima celeridad y eficacia a las necesidades y exigencias de los clientes. Se encuentren donde se encuentren. Además, gracias a su amplia red de filiales y empresas distribuidoras repartidas por todo el mundo, le permite llegar a cualquier cliente, se cual sea su ubicación.

**THE LEADER IN TECHNOLOGY,**

looking for the latest developments to improve the production processes together with a strong investment policy in all our plants to ensure the company's competitiveness and long-term future.

THE LEADER IN QUALITY:

Our quality policy is based on prevention and planning, continuous improvement, customer satisfaction and people participation. In addition to Quality Certification to ISO 9001, Alejandro Altuna S.L.U. operates Quality Management Systems approved by the leading companies in the automotive and residential sectors.

**THE LEADER IN THE
COMMITMENT TO THE ENVIRONMENT:**

At Alejandro Altuna S.L.U. best environmental practice is the norm and not the exception. Our team is part of a business project that respects the environment and contributes to the sustainable development of our community. Alejandro Altuna S.L.U. was the first key manufacturer in the world to achieve ISO 14001 certification for its management system in 2000.

THE LEADER IN SERVICE,

The efficiency of a company is shown in its capacity to respond with the maximum speed and effectiveness to the needs and requirements of its customers, wherever they are based. Moreover, with its extensive network of associate and distribution companies located throughout the world, the company can reach any customer, wherever based.

ESPAÑOL

AVISO LEGAL

Conforme a las disposiciones legales vigentes relativas a la propiedad industrial, las marcas o nombres comerciales indicados en este catálogo son propiedad exclusiva de los fabricantes de cilindros y cerraduras, así como de los fabricantes de automóviles, otros constructores, distribuidores y usuarios.

Dichas marcas o nombres comerciales se indican en calidad simplemente informativa con el fin de reconocer con rapidez la cerradura a la que corresponden nuestras piezas.

Este catálogo está reservado exclusivamente a profesionales de la reproducción de llaves que utilizan piezas JMA.

Los datos referentes a los productos de este catálogo tienen carácter indicativo. Manteniendo siempre las características básicas, nos reservamos el derecho de realizar, sin previo aviso, modificaciones técnicas, estéticas o de otro tipo, por razones de evolución de los productos en cuestión.

Algunos modelos que están en este nuevo catálogo podrán recibirlos tanto con la marca y la referencia JMA como con otra marca del grupo ALTUNA.

EUSKERA

LEGE-OHARRA

Jabetza industrialari buruz indarrean dauden lege-xedape-nekin bat etorri, katalogo honetan zehaztutako merkataritza-markak edo izenak zilindro eta sarraileen fabrikatzaileen nahiz ibilgailuen fabrikatzaileen eta beste eraikitzaile, banatzaile eta erabiltzaile batzuen jabetza eskusibokoak dira.

Merkataritza-marka edo izen horiek zehaztasun gehiago emateko adierazten dira, gure piezak zein sarraileri dagozkion berehala ikusi ahal izateko.

Katalogo hau giltzen kopiak egiteko JMA piezak erabiltzen dituzten profesionalentzako da soilik.

Katalogo honetako produktuei buruzko datuek izaera adierazgarria dute. Oinarrizko ezaugarriak gordez, produktuen bilakaeraren ondoriozko aldaketa teknikoak, estetikoak edo bestelakoak egiteko eskubidea dugu, aurretik horren berri eman beharrik gabe.

Katalogo berri honetan dauden eredueta batak JMA marka eta erreferentziarekin nahiz ALTUNA taldeko beste marka batekin jaso ahal izango dira.

ENGLISH

LEGAL WARNING

In accordance with legal requirements relating to industrial property rights, the trademarks or trade names indicated in this catalogue are the exclusive property of the manufacturers of the cylinders and locks, as well as automobile manufacturers, other constructors, distributors and users.

The aforementioned trademarks or trade names are indicated simply for information purposes so that the lock to which our parts correspond can be recognised quickly and easily. This catalogue is for the exclusive use of professional key copiers who use JMA parts.

Data referring to the products in this catalogue are indicative in nature. Although the basic characteristics are maintained at all times, we reserve the right to make, without previous notice, any technical, aesthetic or other types of changes involved in the development of the products in question. Some of the keys in this new catalogue could be received either with the JMA reference and trademark or with another trademark from the ALTUNA group.

FRANÇAIS

MENTIONS LEGALES

Conformément aux dispositions légales en vigueur relatives à la propriété industrielle, les marques ou les dénominations commerciales citées dans ce catalogue sont la propriété exclusive des fabricants de cylindres et de serrures ainsi que des constructeurs de voitures, autres constructeurs, distributeurs et utilisateurs.

Ces marques ou dénominations commerciales sont indiquées à titre de simple information afin de connaître rapidement à quelle serrure nos ébauches sont destinées.

Ce catalogue est exclusivement réservé aux professionnels de la reproduction de clés, utilisant des ébauches JMA.

Les renseignements sur les produits de ce catalogue sont donnés à titre indicatif. Tout en gardant les caractéristiques de base, nous nous réservons le droit d'apporter, sans préavis, des modifications techniques, esthétiques ou autres, dues à l'évolution des produits en question.

Des ébauches de ce catalogue pourront être livrées soit avec la marque et référence JMA soit avec une autre marque du groupe ALTUNA.

DEUTSCH

RECHTSHINWEIS

In Übereinstimmung mit den geltenden gesetzlichen Vorschriften bezüglich des gewerblichen Eigentums sind die im vorliegenden Katalog aufgeführten Marken und Firmennamen ausschließliches Eigentum der Zylinder- und Schloßhersteller, sowie der Automobilhersteller und anderer Konstrukteure, Vertreter und Benutzer.

Diese Marken und Firmennamen werden nur zu Informationszwecken aufgeführt, mit dem Ziel, auf schnelle Weise zu erkennen, zu welchem Schloß unsere Teile gehören.

Dieser Katalog ist ausschließlich für Fachleute des Bereichs der Schlüsselreproduktion gedacht, die JMA-Teile verwenden.

Die Daten bezüglich der Produkte des vorliegenden Katalogs haben informativen Charakter. Bei Aufrechterhaltung der grundlegenden Eigenschaften behalten wir uns das Recht vor, aus Gründen der Entwicklung der entsprechenden Produkte und ohne Vorankündigung technische, ästhetische oder andere Änderungen vorzunehmen. Einige Modelle des neuen Katalogs können Sie sowohl mit der Marke und der Bezeichnung JMA erhalten, als auch mit jeder anderen Marke der Gruppe ALTUNA.

THE KEY TO EXCELLENCE

GLOBALLY UNLOCKING MILLIONS OF DOORS DAILY



ÍNDICE
AURKIBIDEA
INDEX
INDEX
VERZEICHNIS



ESPECIALISTA
SPECIALIST

THE KEY TO EXCELLENCE
GLOBALLY UNLOCKING MILLIONS OF DOORS DAILY

REF.	PAG.
26-M	C9
7-S	C9
AB-1T	A10
AB-2T	A10
AB-3T	A10
AB-4T	A10
ABC-6	A10
ABC-7	A10
ABL-1	B10 C8
ABL-2	B10 C8
ABL-3	B10 C8
ABL-3D	B10 C8
ABL-4	B10 C8
ABL-7	B10 C8
ABU-16	A10
ABU-29P	B10 C8
ABU-3	C8
ABU-34	A10
ABU-61	A10
ABU-63	A10
ABU-66	A10
ABU-81	A10
ABU-91	A10
ABU-96	A10
ADPLE-11	C8
ADPLE-22	C8
ADPLE-33	C8
ADPLE-44	C8
ADPLE-55	C8
AGA-12	A10
AGA-1T	A10
AGA-25	A10
AGA-29	A10
AGA-2T	A10
AGA-38	A10
AGA-39	A10
AGA-42	A10
AGA-43	A10
AGA-44	A10
AGA-48	A10 A11
AGA-49	A11
AGA-50	A11
AGA-55D	A11
AGB-2	A11
AGB-4	A11
AGB-5	A11
ALA-1X	B10
AMG-8D	A11
AMG-9D	A11
AMG-10	A11
AMG-10D	A11
AMG-11	A11
ANC-2	C8
AP-1D	A11
AP-3D	A11
AP-4D	A11
AP-5D	A11
ARC-17DP	C8

REF.	PAG.
ARC-17P	C8
ARFE-2	C8
AX-2P	A11
AX-5DP1	A11
AX-6	A11
AZ-1I	B10
AZ-1D	B10
AZ-7	A11
AZ-8D	A11
AZ-9	A11
AZ-9D	A11
AZ-12	A11
AZ-14	A11 A12
AZ-17D	B10
AZ-29	A12
AZ-32	A12
BA-1D	B10
BAG-1	A12
BAI-8D	A12
BAI-9D	A12
BDA-1	A12
BEY-1D	A12
BEY-2D	A12
BIL-1T	A12
BKY-1	A12
BKY-2	A12
BLU-1X	B10
BM-1P	A18
BM-4	A18
BM-5P	A18
BM-6P	A18
BM-7P	A18
BRAS-1	A12
BRI-10	B10
BRI-12	B10
BRI-16	A12
BRI-25	A12
BRI-26	A12
BRI-27	A12
BRI-28	A12
BRI-29	A12
BRI-30	A12
BRI-31	A12
BRI-33	A12
BRI-34	A12
BRI-3X	B10
BRN-1D	A12 A13
BRN-2D	A13
BUL-1	A13
BUR-33	A13
BUR-4X	B10
BUR-5X	B10 B11
BYP-1D	A13
CARAT P3	A29
CAY-2	A13
CE-114	A13
CHI-1T	A13
CHU-10	A13

REF.	PAG.
CI-14	A13
CI-17	A13
CI-21	A13
CI-25	A13
CI-26	A13
CI-30	A13
CI-31	A13
CI-32	A13
CI-33	A13
CI-35	A13
CI-48	A13
CI-48P	A13
CI-56	A13
CI-57	A13 A14
CI-59	A14
CI-60	A14
CI-66	A14
CI-71	A14
CI-71P	A14
CI-72	A14
CI-72P	A14
CI-73	A14
CI-73P	A14
CI-75P	A14
CI-76P	A14
CI-77P	A14
CI-78P	A14
CI-79P	A14
CI-80P	A14
CI-81	A14
CI-81P	A14
CI-82P	A14
CI-83P	A14
CI-84P	A14
CIT-1C1	A29
CIT-1P	A29
COR-37	A14
COR-77	A14
CVL-9D	A14
DAF-2	A14
DAF-3D	A14 A15
DAF-4D	A15
DEK-3	A15
DEK-4	A15
DEK-8	A15
DEK-11	A15
DEK-16	A15
DEK-17	A15
DEN-1	C8
DEN-2	C8
DIE-1	C8
DLC-1	A15
DLC-2	A15
DLC-3	A15
DO-3	A16
DO-4	A16
DOM-17I	A15
DOM-22	A15

REF.	PAG.
DOM-30	A15
DOM-31	A15
DOM-32	A15
DOM-33	A15
DOM-34	A15
DOM-39	A15
DOM-43	A15
DOM-56D	A15
DOM-63D	A15
DOM-B1	A15
DOM-B6	A16
DR-1	A15
DR-2D	A15
ELZ-10	A16
ELZ-10D	A16
ELZ-13	A16
EU-12	A16
EU-15P	A16
EU-16DP	A16
EZ-DS10	A16
EZ-DS10E	A16
EZ-DS15	A16
EZ-DS15R	A16
FAC-19	A16
FAC-23	A16
FAC-24	A16
FAC-25	A16 A17
FAV-1D	A17
FAV-2	A17
FAY-1D	A17
F-B-2D	B11
F-B-2I	B11
F-B-4	B11
F-B-5	B11
F-B-6	B11
F-B-7	B11
F-B-8	B11
F-B-9	B11
F-B-10	B11
F-B-11	B11
F-B-12	B11
F-B-13	B11 B12
F-B-14	B12
F-B-15	B12
F-B-16	B12
F-B-17	B12
F-B-18	B12
F-B-26	B12
F-B-27	B12
F-B-28	B12
F-B-29	B12
F-B-30	B12
F-B-32	B12
FER-2D	A17
FF-13	A17
FI-16P	A28
FIC-2	A17
FIC-3	A17

ÍNDICE POR REFERENCIA

REFERENCE INDEX

REF.	PAG.
FIC-4	A17
FIC-18	A17
FM-1X	B12
FO-22P	C8
FO-24C3	A18
FO-24C8	A18
FO-24C9	A18
FO-24P	A18
FO-4P	C8
FO-6P	A17 B12 C8
FON-1E	A17
FON-2E	A17
FON-3E	A17
FON-5E	A17
FON-6E	A17
FTH-16	A17
FTH-23	A17
FTH-24	A17
FTH-25	A17
FTH-26D	A17
FTH-29	A17
FTH-30	A17
FTH-7	A17
FV-3	A17
GDA-1P	A17
GE-2 Pextra Flex	B12 B13
GEV-3D	A17
GIOB-3P	A17 A18
GM-49DP	A17
GOD-1	A18
GOD-2	A18
HB-1	A18
HEC-1	C8
HOK-1D	A18
HOND-17P	A18
HOND-31P	A18
HTE-50	A18
HU-2P	A18
HU-2P-1	A18
HU-4C1	A18
HU-DHP	A18
HU-DHP1	A18
HU-DHP2	A18
HU-DHP3	A18 A19
HU-DNP	A19
HU-HAAP	A19
HU-HAAP1	A19
HU-HCAP	A19
HY-18P	A20
HY-18P1C1	A20
HY-19P	A20
HY-19P5	A20
IF-2	A20
IF-3P	C9
IF-4	A20
IF-6	A20
IF-8	A20
INCE-1E	A20

REF.	PAG.
IR-1P	A20
IS-6D	A20
IS-10	A20
IS-10P	A20
IS-14D	A20
IS-20	A20
ITO-2D	A20
ITO-3D	A20
JAR-1E	A20
JAU-1P	A27 C9
JAU-2P	A27 C9
JIS-4P	A20
JPM-1E	A20
JPM-2E	A20
KA-1	A20
KA-2	A20
KA-3	A20 A21
KA-4	A21
KA-5	A21
KA-6	A21
KA-7	A21
KA-8	A21
KA-10	A21
KA-11	A21
KAE-1	A21
KAE-2	A21
KAE-4	A21
KAE-10D	A21
KAE-11D	A21
KAE-12D	A21
KAE-14	A21
KE-1	A21
KE-3	A21
KE-4	A21
KE-5	A21
KE-6	A21 A22
KI-7P	A22
KI-9P	A22
KI-11P	A22
KI-12DP	A22
KI-12P	A22
KM-1P	A22
LAP-1E	A22
LAP-2E	A22
LAP-4	A22
LAP-8D	A22
LAP-10D	A22
LAP-11D	A22
LAP-13P	A22
LAP-17P	A22
LAP-20P	A22
LAP-21P	A22
LAP-22P	A22
LAP-23P	A22
LIN-13	A22
LIN-19D	A22
LIN-21D	A22
LIN-26D	A22

REF.	PAG.
LYF-1T	A22
LYF-2T	A22
MAG-2DP	A22
MAS-15P	A22 A23
MASL-1	A23
MAU-1	A23
MAU-2	A23
MAZ-12P1	A23
MCM-10	A23
MCM-13D	B13
MCM-15E8	A23
MCM-16	A23
MCM-18D	B13
MCM-21D	A23
MCM-27	A23
MCM-30	B13
MCM-4SS	A23
ME-2P	A19
ME-3P	A19
ME-4P	A19
ME-5P	A19
ME-6P	A19
ME-7P	A19
ME-8P	A19
ME-10P	A19
ME-11P	A19
ME-12P	A19
MER-1T	A23
MER-3T	A23
MGA-2	A23
MH-1	A23
MIL-1	C9
MIL-2	C9
MIW-2	B13
MIW-3	B13
MIW-4	B13
MLM-4	A23
MLM-8	A23
MSM-1	A23
MSV-1	B13
MSV-2	B13
MT-1P	A23
MT-2D	A23
MUL-T2P	A23
MUL-T3P1	A23 A24
MUL-T3PL	A24
MUL-T4P	A24
MUL-T5P	A24
MUL-T7P	A24
MUL-T8P1	A24
MUL-T9P1	A24
MUL-T10P	A24
MUL-T11P1	A24
MUL-T16P	A24
NE-40	A24
NE-40P-1	A24
NE-41P	A24
NE-51P2	A24

REF.	PAG.
OJ-20/4	A24
OJ-Q	A24
OMC-3	A25
OMC-4	A25
OMC-7	A25
OP-11C1	A19
OP-11C3	A19
OP-11P1	A19
OP-WHC	A19
OP-WHP	A19
OP-WYP	A20
ORIGINAL BRAVUS	A10 A25
ORIGINAL C-2/C-3/C-4	A22
ORIGINAL C-5	A22
ORIGINAL CS7 / CSP-7 / CS8	A26
ORIGINAL CX6	A12
ORIGINAL D12	B10
ORIGINAL DUAL XP	A12
ORIGINAL EUROVAL	A14
ORIGINAL GERA WS / WS XP / PLUS	A17
ORIGINAL INTE-RACTIVE L / R	A24
ORIGINAL IX DAS 138	A16
ORIGINAL IX5 DAS 038	A16
ORIGINAL IX6 KG 102/121	A16
ORIGINAL IX6 SR 132/232	A16
ORIGINAL MT5	A24
ORIGINAL NW4	A23
ORIGINAL RS8	B11
ORIGINAL ST15	A26
ORIGINAL ST6	A26
ORIGINAL ST8	A26
ORIGINAL VRX	A29
ORIGINAL WS 50 NW	A12
ORIGINAL WS 50 RA, RK, RZ	A12
ORIGINAL WSM	A13
ORIGINAL XP/SP	B10
ORIGINAL X-TRA	A30
PC-1T	A25
PC-3TP	A25
PCI-1T	A25
PEN-2	A25 C9
PEU-1C1	A29
PEU-2C1	A29
PEU-1P	A29
PFA-13D	A25
PFA-14D	A25
PFA-15D	A25
PFA-16D	A25

REF.	PAG.
PIC-1E	A25
PIC-8D	A25
PO-1P	B13
PO-2P	B13
POL-3TEC	A25
POL-4E	A25
POL-5TEC	A25
PR-21	A25
PR-22	A25
PTN-1D	A25
PTN-2D	A25
PTN-3D	A25
ROSE-1	A25
RU-11D	B13
RU-12D	B13
RU-14D	B14
RU-5D	B14
RU-5I	B14
RU-6I	B14
RU-9D	B14
RU-9I	B14
SAA-1P1	A25
SAG-1T	A28
SCR-1	A26
SEA-1	A25
SEA-2	A25
SEC-1	A25 A26
SEC-2	A26
SEC-3	A26
SER-1T	A26
SER-3D	A26
SID-1	A26
SID-2	A26
SIP-4P3	A28
SIP-4P4	A28
SIX-3P	B14
SMR-1P	A26
SOF-1	B14
SOF-2	B14
SOL-1	C9
SPI-1	A26

REF.	PAG.
SPI-1D	A26
STS-35	A26
STS-36	A26
STS-37	A26
STS-38	A26
STS-B1	A26
STS-T14	A26
STS-TV3	A26
STS-TV5	A26
STS-TV8	A26
STS-TV9	A26
STS-X5	A26
STS-X6	A26
SUB-2P	A26 A27
TC-1	A27
TC-3	A27
TE-8I	B14
TE-23	B14
TE-28	B14
TEC-2	A27
TE-T10	A27
TE-T10D	A27
TE-T11	A27
TE-T12PLUS	A27
TE-T60	A27
TE-T61	A27
TE-T62	A27
TE-T80	A27
TE-T80EH	A27
TE-T80SC	A27
TE-T82	A27
TIT-6	A27
TIT-22	A27
TIT-23	A27
TIT-25	A27
TKY-2	A27
TOV-2	A28
TOV-4	A28
TOV-5	A28
TOV-6	A28
TOV-7	A28

REF.	PAG.
TOV-8D	A28
TOYO-18P	A28
TOYO-30P	A28
TOYO-30P1	A28
TOYO-36P	A28
TOYO-41P	A28
TP00HOND-31P	A18
TRL-4P	A28
TRO-1	A27
TRO-1D	A27
TRU-7	C9
TRU-8P	C9
TX-2	A29
UCEM-5D	A28
UCEM-5I	A28
UCEM-8D	A28
UCEM-8DP	A28
UCEM-13D	A28
UCEM-17D	A28
UCEM-20D	A28
UCEM-21	A28 A29
URB-3D	A29
URB-4D	A29
URKO-4	C9
VA-11	A29
VA-15	A29
VA-17P	A29
VA-25	A29
VA-26	A29
VA-27	A29
VA-28	A29
VA-56	A29
VA-58	A29
VA-70	A29
VA-91	A29
VI-14	A29
WAN-1D	A29
WIL-22	A29
WIN-1D	A29 A30
WIN-1I	A30
WIN-2D	A30

REF.	PAG.
WIN-3D	A30
WIN-4D	A30
WT-1	A30
YA-23	A30
YA-81	A30
YA-280D	A30
YA-281D	A30
YA-282	A30
YA-30	C9
YA-306 (ORIG.)	A30
YAR-1	A30
YAR-2	A30
YAR-3	A30
YAR-4D	A30
ZA-10	A30
ZA-14P	A30

ÍNDICE POR MARCAS

BRAND INDEX

MARCA - MARKA - BRAND MARQUE - MARKE	PAG.
ABC	A10
ABLOY	B10, C8
ABSA	A10
ABUS	A10, B10, C8
ADPLE	C8
AGA	A10, A11
AGB	A11
ALA	B10
AMIG	A11
ANCHOR	C8
APEX	A11
ARCU	C8
ARFE	C8
ASSA / RUKO / TRIO-VING	B10
AXA	A11
AZBE	A11, A12, B10
BAGEM	A11
BAODEAN	A11
BASI	A12, B10
BEY	A12
BILMA	A12
BKS	A12
BLUMA	B10
BORKEY	A12
BRAS	A12
BRICARD	A12, B10
BRISANT	A12, A13
BULAT	A13
BURG	A13, B10, B11
BYP	A13
CAYS	A13
CES	A13
CHICAGO	A13
CHUBB	A13
CISA	A13, A14
CORBIN	A14
CVL	A14
DAF	A14, A15
DEKABA	A15
DELCA	A15
DENNY	C8
DIEBOLD	C8
DIERRE	A15
DOM	A15, A16, B11
DOMUS	A16
ELZETT	A16
EUROLOCKS	A16
EZCURRA	A16
FAB	B11, B12
FAC	A16, A17
FAVOUR	A17
FAYN	A17
F-CV	A17
FERONERIA	A17
FF	A17
FIAM	B12
FICHET	A17
FONTAINE	A17

MARCA - MARKA - BRAND MARQUE - MARKE	PAG.
FORD	A17, B12, C8, C9
FTH	A17
G.M.	A17
GE GE	B12, B13
GERA	A17
GERDA	A17
GEVY	A17
GIOBERT	A17, A18
GODREJ	A18
HB	A18
HECTOR	C9
HOK	A18
HONDA	A18
HTEC	A18
HUF	A18, A20, B13
HYUNDAI	A20
IFAM	A20, C9
INCECA	A20
IR	A20
ISEO	A20
ITO	A20
JARDI	A20
JIS	A20
JPM	A20
KABA	A20, A21
KALE	A21
KESO	A21
KIA	A21, A22
KTM	A22
LAPERCHE	A22
LINCE	A22
LYF	A22
MAGNUM	A22
MASTER	A22, A23
MASTER LOCK	A23
MAUER	A23
MAZDA	A23
MCM	A23, B13
MERONI	A23
MG MONTI	A23
MHA	A23
MILES	C9
MIWA	B13
MLM	A23
MOTTURA	A23
MSM	A23
MSV	B13
MUL.T.LOCK	A23, A24
NEIMAN	A24
OJMAR	A24
OMEC	A25
P&C I.	A25
P.C.	A25
PENZMASH	A25, C9
PFAFFENHAIN	A25
PICARD	A25
POLLUX	A25

MARCA - MARKA - BRAND MARQUE - MARKE	PAG.
POTENT	A25
PREFER	A25
RIL	C9
ROSSETTI	A25
RUKO	B13, B14
SAAB	A25
SEA	A25
SECUREMME	A25, A26
SECURITAL	A26
SERRALLER	A26
SERRETA	C9
SIDESE	A26
SIMPLEX	B14
SMART	A26
SOFER	B14
SOLER	C9
SPIDER	A26
STS	A26
SUBARU	A26, A27
TARONI	A27
TECON	A27
TECSESA	A27
TESA	A27, B14
TIBBE	A27, C9
TITAN	A27
T-KEY	A27
TOVER	A28
TOYOTA	A28
TRELOCK	A28
TRUPER	C9
TRW-SIPEA	A28
TSAG	A28
UCEM	A28, A29
UNIVERSAL	A29
URBIS	A29
URKO	C9
VACHETTE	A29
VALEO	A29
WANJIN	A29
WILKA	A29
WINKHAUS	A29, A30
WT	A30
YALE	A30, C9
YALE (ORIG.)	A30
YARDENI	A30
ZADI	A30

MÁQUINAS DUPLICADORAS

*MAKINA MEKANIKOAK
KEY CUTTING MACHINES
MACHINES A REPRODUIRE
SCHLÜSSELKOPIERMASCHINEN*



PARA LLAVES DE SEGURIDAD

*SEGURITATEZKO GILTZENTZAT
FOR DIMPLE KEYS
POUR CLES DE SECURITE
FÜR BOHRMULDENSCHLÜSSEL*

THE KEY TO EXCELLENCE
GLOBALLY UNLOCKING MILLIONS OF DOORS DAILY



MÁQUINAS / MACHINES

CAPRI

CAPRI es la máquina duplicadora de JMA para llaves de seguridad, regata, tubulares y especiales. Con la máquina duplicadora CAPRI damos un salto cualitativo sobre el resto de máquinas duplicadoras manuales del mercado, al incorporar un novedoso sistema patentado de medición de la fuerza o presión en el duplicado, haciendo que el trabajo de copia sea una tarea sencilla y precisa.

CAPRI is JMA duplicating machine for dimple, channel, tubular and special keys. With the CAPRI duplicating machine we make a qualitative jump over the rest of manual duplicating machines on the market, by incorporating an innovative patented system for measuring the strength or pressure in the duplication, making the copy task easy and precise.



CAPRI SMART

CAPRI-SMART es la máquina duplicadora de JMA para llaves de seguridad, regata y especiales, diseñada para los profesionales de la duplicación. Una versión sencilla de la máquina duplicadora más avanzada del mercado CAPRI. La robustez de su diseño, las nuevas tecnologías incorporadas y materiales de última generación utilizados, hacen de ella una duplicadora duradera que mantiene siempre su precisión de duplicado.

CAPRI-SMART is the JMA duplicating machine for dimple, channel and special keys, designed by professionals from the duplicating world. A simple version of the most advanced duplicating machine of the market, the CAPRI. The strength of its design, the new technologies and last generation materials, make this a long-lasting duplicator that always maintains precision of duplication.



MULTICODE

Con la nueva MULTICODE, JMA le ofrece la solución profesional 'todo en uno' para su negocio. Su multifuncionalidad le permite copiar llaves planas, de seguridad y de automoción sin cambiar de máquina. Conozca su potencia y rapidez para mecanizar llaves de una sola pasada y descubra su última tecnología, que incorpora una tablet y la APP JMAKEYPRO para facilitarle el duplicado de todo el catálogo JMA y sus equivalencias.

With the new MULTICODE, JMA offers an all-in-one professional solution for your business. Its multi-functional nature means it can cut to code and copy cylinder, dimple and vehicle keys without needing to switch machines. Witness its power and speed for cutting keys in a single motion and discover its cutting-edge technology, which uses a tablet and the JMAKEYPRO app for duplicating the entire catalogue of JMA keys and their equivalents.



NOTA: La máquina Multicode tiene su propio catálogo especialista. Para consultar dicha información visite el siguiente enlace:

NOTE: The Multicode machine has its own specialist catalog. To check this information, visit the following link:



LLAVES DE SEGURIDAD

DIMPLE KEYS

NEO

Neo es la máquina en la que se combinan la precisión y la sencillez a la hora de duplicar las llaves de seguridad, regata y especiales. Reúne nuevas prestaciones como la iluminación Led y la pantalla protectora en la zona de trabajo. Novedosa mordaza donde se han incluido el amarre de llaves de seguridad y llaves de automoción de regata de corte láser sin necesidad de adaptador.

Neo is the machine that combines precision and simplicity to duplicate dimple, channel and special keys. It includes new features like Led illumination and a protective screen in the work area. This machine is the first in its category to incorporate a new clamp where the clamping of security keys, and laser cut automotive channel keys has been incorporated without the need of an adaptor (VAG ® keys group fixing area and another for Mercedes® keys).



X-CODE

X-Code es la máquina duplicadora de llaves a código especiales, seguridad y automóvil, controlada electrónicamente. su funcionamiento puede ser de forma autónoma o mediante la conexión a un PC.

X-Code is a duplicating machine for special code, security and automobile keys with electronic control. It can operate independently or by connection to a PC.





FRESAS / MILLING CUTTERS

CODE	A	B	C	D	E	PARA-FOR	MAT
F1	90	0,8		45	6	CAPRI-CAPRI S.-NEO-XCODE	HSS
F1A	90	0,8		45	8	CAPRI-CAPRI S.-NEO-XCODE	HSS
F1W	90	0,8		45	6	CAPRI-CAPRI S.-NEO-XCODE	W
F3			1,5	45	6	CAPRI-CAPRI S.-NEO-XCODE	HSS
F3W			1,5	45	6	CAPRI-CAPRI S.-NEO-XCODE	W
F4	90	0,4		45	6	CAPRI-CAPRI S.-NEO-XCODE	HSS
F5	90	0,9		45	6	CAPRI-CAPRI S.-NEO-XCODE	HSS
F5W	90	0,9		45	6	CAPRI-CAPRI S.-NEO-XCODE	W
F6	106	1		45	6	CAPRI-CAPRI S.-NEO-XCODE	HSS
F7	70	0,8		45	6	CAPRI-CAPRI S.-NEO-XCODE	HSS
F8			4	45	6	CAPRI-CAPRI S.-NEO-XCODE	HSS
F8W			4	45	6	CAPRI-CAPRI S.-NEO-XCODE	W
F9			5,95	45	6	CHICAGO	HSS
F9W			5,95	45	6	CHICAGO	W
F11			2,5	45	6	CAPRI-CAPRI S.-NEO-XCODE	HSS
F11W			2,5	45	6	XCODE	W
F11A (HC-2)			2,5	45	6	CAPRI-CAPRI S.-NEO-XCODE	HSS
F12A	100	0,6		45	6	CAPRI-CAPRI S.-NEO-XCODE	HSS
F12B	100-90	2,1-2,9		45	6	CAPRI-CAPRI S.-NEO-XCODE	HSS
F13	100	0,8		45	6	CAPRI-CAPRI S.-NEO-XCODE	HSS
F13W	100	0,8		45	6	CAPRI-CAPRI S.-NEO-XCODE	W
F14	100	1,45		45	6	CAPRI-CAPRI S.-NEO-XCODE	HSS
F15 + plantillas		2	5	45	6	CAPRI-CAPRI S.-NEO-XCODE	HSS
F16	130	0,6		45	6	CAPRI-CAPRI S.-NEO-XCODE	HSS
F17			3	45	6	CAPRI-CAPRI S.-NEO-XCODE	HSS
F17W			3	45	6	XCODE	W
F19	90	1,2		45	6	CAPRI-CAPRI S.-NEO-XCODE	HSS
F19W	90	1,2		45	6	CAPRI-CAPRI S.-NEO-XCODE	W
F21	85	0,72		45	6	CAPRI-CAPRI S.-NEO-XCODE	HSS
F22			2,4	45	6	CAPRI-CAPRI S.-NEO-XCODE	HSS
F23	90	0,8	3,3	45	6	CAPRI-CAPRI S.-NEO-XCODE	HSS

CODE	A	B	C	D	E	PARA-FOR	MAT
F23W	90	0,8	3,3	45	6	CAPRI-CAPRI S.-NEO-XCODE	W
F24W	95	1		45	6	CAPRI-CAPRI S.-NEO-XCODE	W
F25W	95	1,1		45	6	CAPRI-CAPRI S.-NEO-XCODE	W
F27	90	0,7		45	6	CAPRI-CAPRI S.-NEO-XCODE	HSS
F27W	90	0,7		45	6	CAPRI-CAPRI S.-NEO-XCODE	W
F28W	60	1,4		45	6	XCODE	W
F29W	100	0,6		45	6	XCODE	W
F30W	100	0,5		45	6	XCODE	W
F31W	90	0,6		45	6	XCODE	W
F32	90	0,6	3	45	6	CAPRI-CAPRI S.-NEO-XCODE	HSS
F32W	90	0,6	3	45	6	CAPRI-CAPRI S.-NEO-XCODE	W
F33			2	45	6	CAPRI-CAPRI S.-NEO-XCODE	HSS
F33W			2	45	6	XCODE	W
F34	90	1,4		45	6	CAPRI-CAPRI S.-NEO-XCODE	HSS
F-35W	90	3	3	45	6	CAPRI-CAPRI S.-NEO-XCODE	W
F-40	90	0,2		45	6	CAPRI-CAPRI S.-NEO-XCODE	HSS
F-40W	90	0,2		45	6	XCODE	W
F43	90	0,7		45	6	CAPRI-CAPRI S.-NEO-XCODE	HSS
F-49W	83,52	0,8		45	6	XCODE	W
FB	90-90	2,7-3,3		45	6	CAPRI-CAPRI S.-NEO-XCODE	HSS
FC	80-80			45	6	CAPRI-CAPRI S.-NEO-XCODE	HSS
FBW	90-90	2,7-3,3		45	6	CAPRI-CAPRI S.-NEO-XCODE	W
FCW	80-80			45	6	CAPRI-CAPRI S.-NEO-XCODE	W
FS-31	60-60	0,64-0,95		45	6	CAPRI-CAPRI S.-NEO-XCODE	HSS

CODE	F	G	C	D	E	PARA-FOR	MAT
F18	10	1		45	6	CAPRI-CAPRI S.-NEO-XCODE	HSS
F20	16	1,25		45	6	CAPRI-CAPRI S.-NEO-XCODE	HSS
F36	12	2		45	6	XCODE	HSS
F37	12	1,3		45	6	XCODE	HSS

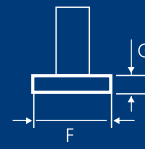
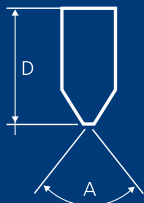

SIMBOLOGÍA / SYMBOLS

W

Fresa de metal duro
Metal gogorreko fresa
Hard metal cutters
Fraise en métal dur
Hartmetallfräse

HSS

Acero extra rápido
Altzairu estra azkarra
High-speed steel
Acier extra rapide
Extraschneller Stahl



Diámetro
Diametroa
Diameter
Diametre
Durchmesser



Altura de corte
Ebaketa altuera
Cutting height
Hauteur de coupe
Schnitthöhe



Diámetro de corte
Ebaketa diametroa
Cutting diameter
Diàmètre de coupe
Schneidmesser



Ángulo de corte
Ebaketa-angelua
Cutting angle
Angle de coupe
Schnittwinkel



Base
Oinarri
Base
Base
Basis



Distancia corte
Ebaketaren distantzia
Cutting distance
Distance coupe
Schnittabstand



Largo
Luzeera
Length
Longueur
Länge



FRESAS / MILLING CUTTERS

F-1	F-1A	F-1W	F-3	F-3W	F-4	F-5	F-5W	F-6	F-7	F-8	F-8W	F-9	F-9W	F-11	F-11A	F-11W	F-12A	F-12B	F-13	F-13W
F-14	F-15	F-16	F-17	F-17W	F-18	F-19	F-19W	F-20	F-21	F-22	F-23	F-23W	F-24W	F-25W	F-26	F-27	F-27W	F-28W	F-29W	F-30W
F-31W	F-32	F-32W	F-33	F-33W	F-34	F-35W	F-36	F-37	F-40	F-40W	F-43	F-49W	F-B	F-BW	F-C	F-CW	F-S31			



PALPADORES / TRACERS

P-1	P-3	P-4	P-5	P-6	P-7	P-8	P-11	P-12A	P-12B	P-12X	P-13	P-14	P-15	P-16	P-18	P-19	P-21	P-22	P-23
P-26	P-32	P-33	P-34	P-34	P-40	P-43	P-B	P-C	PS-31										



ADAPTADORES / ADAPTERS

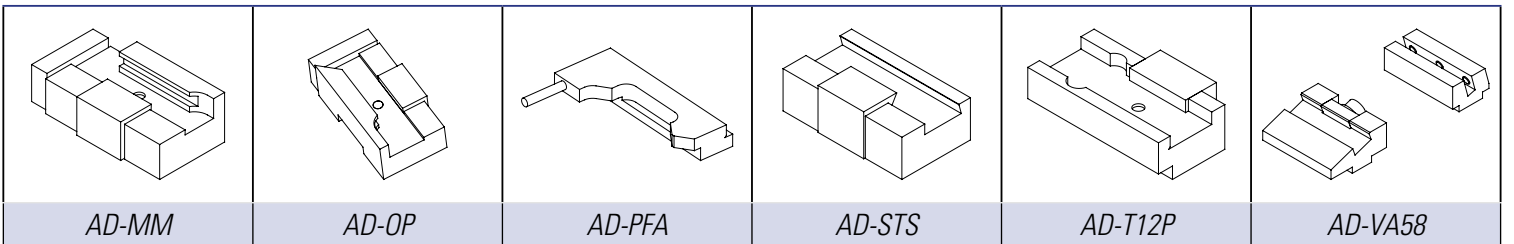
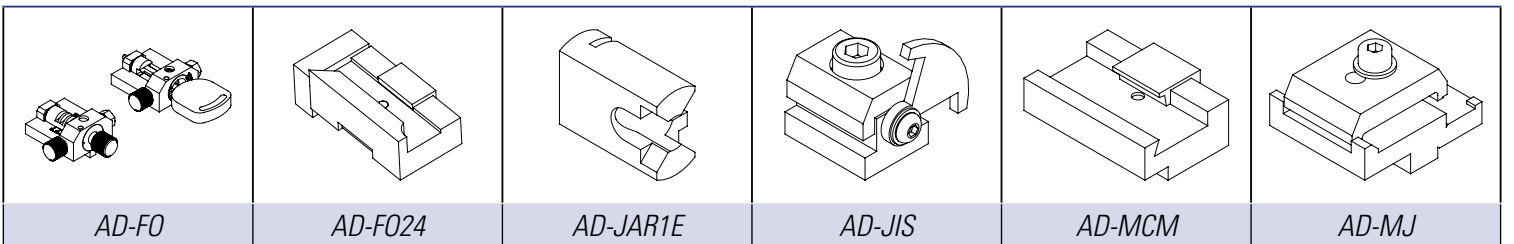
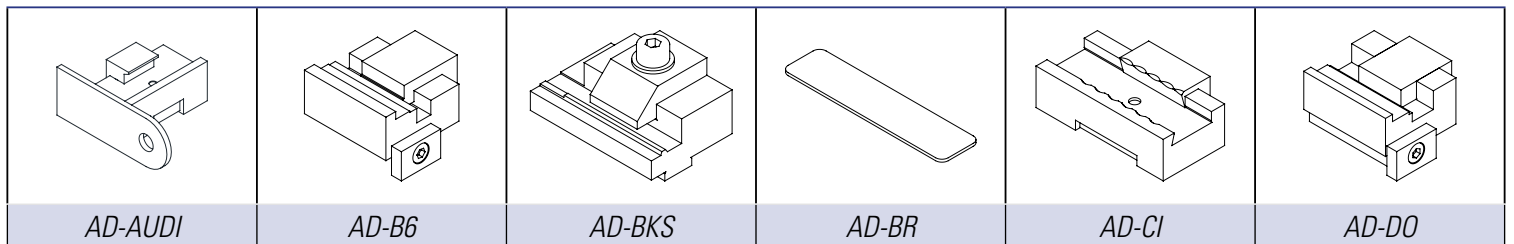
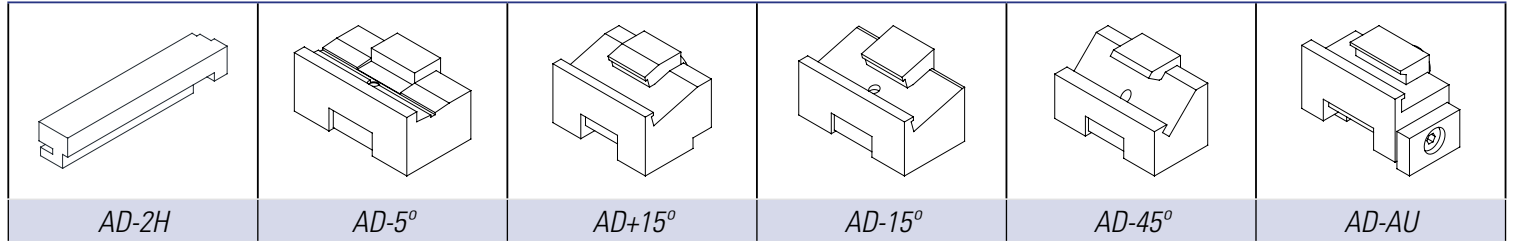

ADAPTADOR	CAPRI	CAPRI S.	NEO	DAKKI	XCODE
AD-2H	X	X			
AD-5°		X	X	X	X
AD+15°					X
AD-15°		X	X	X	
AD-45°		X	X	X	
AD-AU					X
AD-AUDI	X	X	X	X	
AD-B6	X	X	X	X	
AD-BKS	X	X	X	X	
AD-BR	X	X	X	X	X
AD-CI	X	X	X	X	
AD-DO	X	X	X	X	

ADAPTADOR	CAPRI	CAPRI S.	NEO	DAKKI	XCODE
AD-FO	X	X	X	X	
AD-FO24			X	X	
AD-JAR1E	X	X	X	X	
AD-JIS	X	X	X	X	
AD-MCM			X	X	
AD-MJ	X	X	X	X	
AD-MM	X	X	X	X	
AD-OP	X	X	X	X	
AD-PFA	X	X	X	X	
AD-STS	X	X	X	X	X
AD-T12P	X	X	X	X	

LLAVES DE SEGURIDAD

DIMPLE KEYS

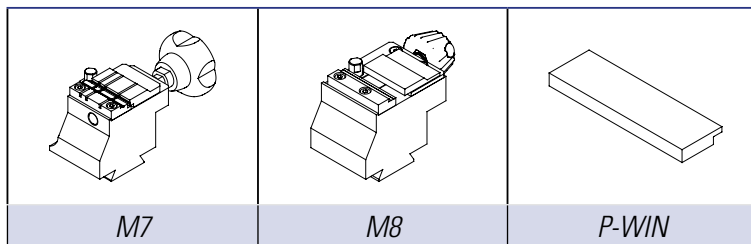
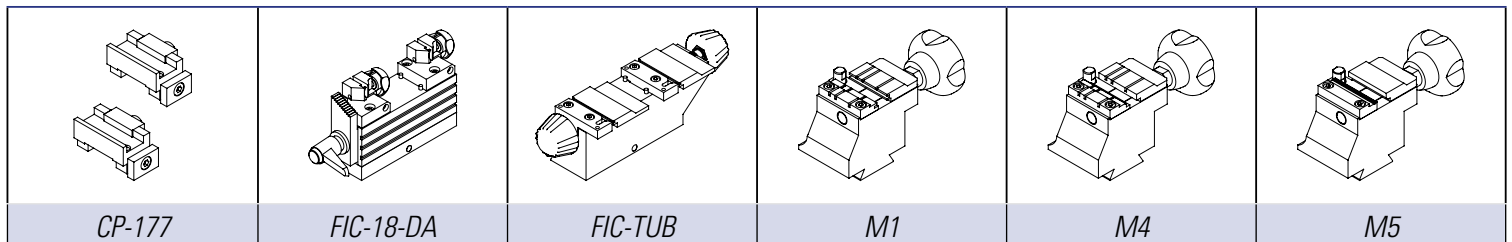
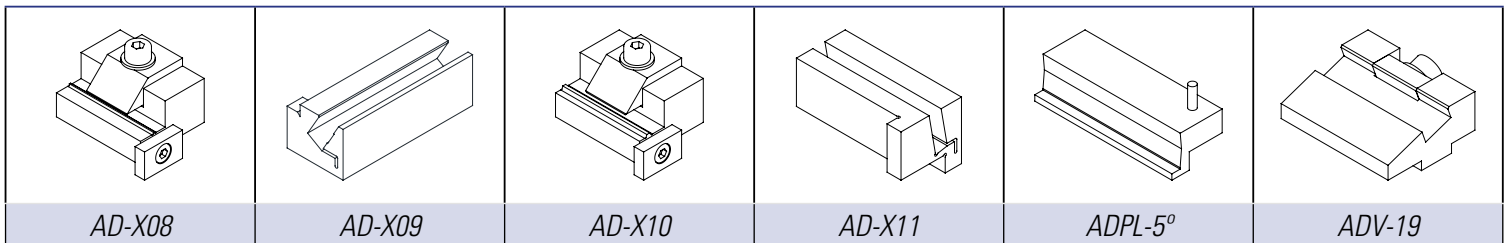
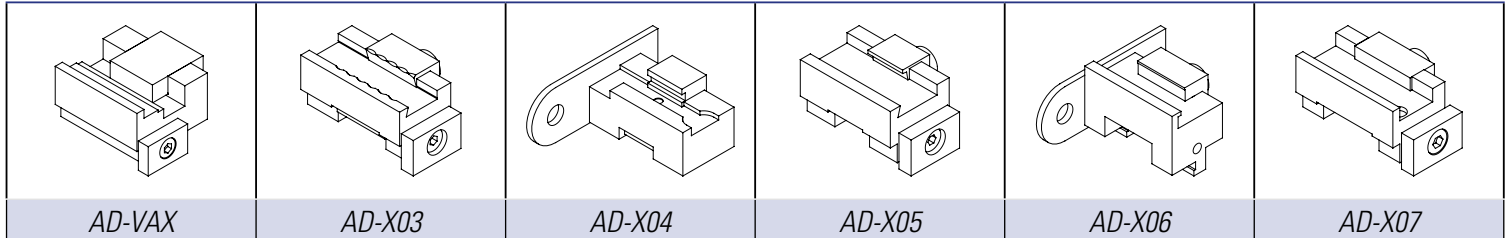

ADAPTADOR	CAPRI	CAPRI S.	NEO	DAKKI	XCODE
AD-VA58		X	X	X	
AD-VAX	X	X	X	X	
AD-X03					X
AD-X04					X
AD-X05					X
AD-X06					X
AD-X07					X
AD-X08					X
AD-X09					X
AD-X10					X
AD-X11					X

ADAPTADOR	CAPRI	CAPRI S.	NEO	DAKKI	XCODE
ADPL-5°	X	X	X	X	X
ADV-19					X
CP-177	X	X	X	X	
FIC-18-DA	X	X			
FIC-TUB		X			
M1					X
M4					X
M5					X
M7					X
M8					X
P-WIN		X	X	X	

FICHA ESPECIALISTA

ESPEZIALISTAREN FITXA

SPECIALIST FILE

FICHE SPÉCIALISÉE

DATENBLATT FÜR FACHLEUTE

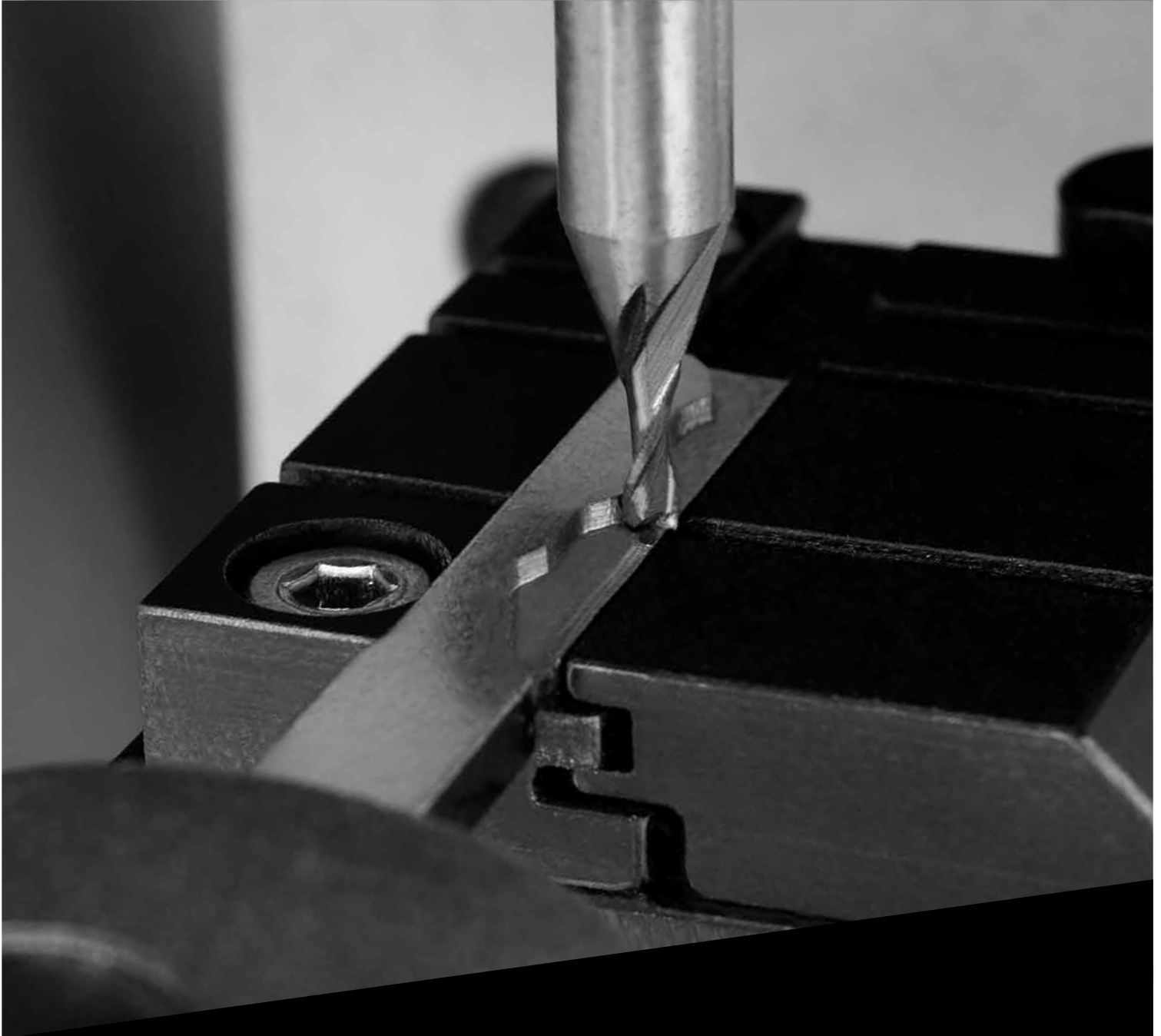

PARA LLAVES DE SEGURIDAD

SEGURITATEZKO GILTZENTZAT





FOR DIMPLE KEYS

POUR CLES DE SECURITE

FÜR BOHRMULDENSCHLÜSSEL

THE KEY TO EXCELLENCE

GLOBALLY UNLOCKING MILLIONS OF DOORS DAILY







®	JMA					
ABC	ABC-6	CAPRI	F-5	P-5		
		CAPRI S.	F-5	P-5		
		XCODE	F-13W			
		NEO-DAKKI	F-5	P-5		
	ABC-7	CAPRI	F-5	P-5		
		CAPRI S.	F-5	P-5		
		NEO-DAKKI	F-5	P-5		
ABSA	AB-1T	CAPRI	F-8	P-8		
		CAPRI S.	F-8	P-8	FIC-TUB	
	AB-2T	CAPRI	F-8	P-8		
		CAPRI S.	F-8	P-8	FIC-TUB	
	AB-3T	CAPRI	F-8	P-8		
		CAPRI S.	F-8	P-8	FIC-TUB	
	AB-4T	CAPRI	F-8	P-8		
		CAPRI S.	F-8	P-8	FIC-TUB	
	ABUS	ABU-16	CAPRI	F-1	P-1	
			CAPRI S.	F-1	P-1	
			NEO-DAKKI	F-1	P-1	
			XCODE	F-1W	P-1	
ABU-34		CAPRI	F-1	P-1	AD-CI	
		CAPRI S.	F-1	P-1	AD-CI	
		NEO-DAKKI	F-1	P-1	AD-CI	
		XCODE	F-1W			
ABU-61		CAPRI	F-1	P-1	AD-CI	
		CAPRI S.	F-1	P-1	AD-CI	
		NEO-DAKKI	F-1	P-1	AD-CI	
		XCODE	F-1W			
ABU-63		CAPRI	F-1	P-1	AD-CI	
		CAPRI S.	F-1	P-1	AD-CI	
		NEO-DAKKI	F-1	P-1	AD-CI	
		XCODE	F-1W			
ABU-66		CAPRI	F-1	P-1	AD-CI	
		CAPRI S.	F-1	P-1	AD-CI	
		NEO-DAKKI	F-1	P-1	AD-CI	
ABU-81		CAPRI	F-1	P-1	AD-CI	
		CAPRI S.	F-1	P-1	AD-CI	
		NEO-DAKKI	F-1	P-1	AD-CI	
ABU-91		CAPRI	F-1	P-1	AD-CI	
		CAPRI S.	F-1	P-1	AD-CI	
	NEO-DAKKI	F-1	P-1	AD-CI		
ABU-96	CAPRI	F-1	P-1	AD-CI		
	CAPRI S.	F-1	P-1	AD-CI		





®	JMA				
ABUS	ABU-96	NEO-DAKKI	F-1	P-1	AD-CI
	ORIGINAL BRAVUS	CAPRI	F-40	P-40	AD-BR
		CAPRI S.	F-40	P-40	AD-BR
		NEO-DAKKI	F-40	P-40	AD-BR
		XCODE	F-40W		AD-BR
AGA	AGA-12	CAPRI	F-13	P-13	
		CAPRI S.	F-13	P-13	
		NEO-DAKKI	F-13	P-13	
		XCODE	F-27		
	AGA-25	CAPRI	F-13	P-13	
		CAPRI S.	F-13	P-13	
		NEO-DAKKI	F-13	P-13	
	AGA-1T	CAPRI	F-8	P-8	
		CAPRI S.	F-8	P-8	FIC-TUB
		NEO-DAKKI	F-8	P-8	
	AGA-29	CAPRI	F-5	P-5	
		CAPRI S.	F-5	P-5	
		NEO-DAKKI	F-5	P-5	
		XCODE	F-1W		
	AGA-2T	CAPRI	F-8	P-8	
		CAPRI S.	F-8	P-8	FIC-TUB
	AGA-38	CAPRI	F-1	P-1	
		CAPRI S.	F-1	P-1	
		NEO-DAKKI	F-1	P-1	
	AGA-39	CAPRI	F-1	P-1	
		CAPRI S.	F-1	P-1	
		NEO-DAKKI	F-1	P-1	
		XCODE	F-1W		
	AGA-42	CAPRI	F-1	P-1	
CAPRI S.		F-1	P-1		
NEO-DAKKI		F-1	P-1		
XCODE		F-1W			
AGA-43	CAPRI	F-1	P-1		
	CAPRI S.	F-1	P-1		
	NEO-DAKKI	F-1	P-1		
AGA-44	CAPRI	F-1	P-1		
	CAPRI S.	F-1	P-1		
	NEO-DAKKI	F-1	P-1		
	XCODE	F-1W			
AGA-48	CAPRI	F-1	P-1		
	CAPRI S.	F-1	P-1		
	NEO-DAKKI	F-1	P-1		

LLAVES DE SEGURIDAD

DIMPLE KEYS

							
AGA	AGA-48	NEO-DAKKI	F-1	P-1			
		XCODE	F-1W				
		AGA-49	CAPRI	F-1	P-1		
			CAPRI S.	F-1	P-1		
			NEO-DAKKI	F-1	P-1		
	XCODE		F-1W				
	AGA-50	CAPRI	F-1	P-1			
		CAPRI S.	F-1	P-1			
		NEO-DAKKI	F-1	P-1			
		XCODE	F-1W				
	AGA-55D	CAPRI	F-1	P-1			
		CAPRI S.	F-1	P-1			
		NEO-DAKKI	F-1	P-1			
	AGB	AGB-2	CAPRI	F-1	P-1		
			CAPRI S.	F-1	P-1		
NEO-DAKKI			F-1	P-1			
XCODE			F-27				
AGB-4		CAPRI	F-1	P-1			
		CAPRI S.	F-1	P-1			
		NEO-DAKKI	F-1	P-1			
		XCODE	F-27				
AGB-5		CAPRI	F-1	P-1			
		CAPRI S.	F-1	P-1			
		NEO-DAKKI	F-1	P-1			
		XCODE	F-27				
AMIG	AMG-8D	CAPRI	F-5	P-5			
		CAPRI S.	F-5	P-5			
		NEO-DAKKI	F-5	P-5			
	AMG-9D	CAPRI	F-5	P-5			
		CAPRI S.	F-5	P-5			
		NEO-DAKKI	F-5	P-5			
	AMG-10	CAPRI	F-5	P-5			
		CAPRI S.	F-5	P-5			
		NEO-DAKKI	F-5	P-5			
	AMG-10D	CAPRI	F-5	P-5			
		CAPRI S.	F-5	P-5			
		NEO-DAKKI	F-5	P-5			
	AMG-11	CAPRI	F-5	P-5			
		CAPRI S.	F-5	P-5			
		NEO-DAKKI	F-5	P-5			
APEX	AP-1D	CAPRI	F-13	P-13			
		CAPRI S.	F-13	P-13			







							
APEX	AP-1D	NEO-DAKKI	F-13	P-13			
	AP-3D	CAPRI	F-13	P-13			
		CAPRI S.	F-13	P-13			
		NEO-DAKKI	F-13	P-13			
	AP-4D	CAPRI	F-13	P-13			
		CAPRI S.	F-13	P-13			
		NEO-DAKKI	F-13	P-13			
	AP-5D	CAPRI	F-19	P-19			
		CAPRI S.	F-19	P-19			
		NEO-DAKKI	F-19	P-19			
	AXA	AX-2P	CAPRI	F-33	P-33		
			CAPRI S.	F-33	P-33		
			NEO-DAKKI	F-33	P-33		
			XCODE	F-33			
AX-5DP1		CAPRI	F-33	P-33			
		CAPRI S.	F-33	P-33			
		NEO-DAKKI	F-33	P-33			
AX-6		CAPRI	F-1	P-23			
		CAPRI S.	F-1	P-23			
		NEO-DAKKI	F-1	P-23			
AZBE	AZ-7	CAPRI	F15	P15			
		CAPRI SMART	F15	P15			
		DAKKI	F15	P15		P-WIN	
	AZ-8D	CAPRI	F5	P5			
		CAPRI SMART	F5	P5			
		DAKKI	F5	P5			
		XCODE	F5W				
	AZ-9	CAPRI	F13	P13			
		CAPRI SMART	F13	P13			
		DAKKI	F13	P13			
XCODE		F5W					
AZ-9D	CAPRI	F13	P13				
	CAPRI SMART	F13	P13				
	DAKKI	F13	P13				
	XCODE	F24	P13				
AZ-12	CAPRI	F13	P13				
	CAPRI SMART	F13	P13				
	DAKKI	F13	P13				
AZ-14	CAPRI	F13	P13				
	CAPRI SMART	F13	P13				
	DAKKI	F13	P13				







						
AZBE	AZ-14	XCODE	F5W			
	AZ-29	CAPRI	F13	P13		
		CAPRI SMART	F13	P13		
		DAKKI	F13	P13		
		XCODE	F24			
	AZ-32	CAPRI	F13	P13		
		CAPRI SMART	F13	P13		
		DAKKI	F13	P13		
		XCODE	F24			
	BAGEM	BAG-1	CAPRI	F-1	P-1	
CAPRI S.			F-1	P-1		
NEO-DAKKI			F-1	P-1		
XCODE			F-1W			
BAODEAN	BDA-1	CAPRI	F-14	P-14		
		CAPRI S.	F-14	P-14		
		NEO-DAKKI	F-14	P-14		
		XCODE	F-14			
BASI	BAI-8D	CAPRI	F-5	P-5		
		CAPRI S.	F-5	P-5		
		NEO-DAKKI	F-5	P-5		
	BAI-9D	CAPRI	F-5	P-5		
		CAPRI S.	F-5	P-5		
		NEO-DAKKI	F-5	P-5		
	ORIGINAL CX6	XCODE	F-19			
	BEY	BEY-1D	CAPRI	F-13	P-13	
CAPRI S.			F-13	P-13		
NEO-DAKKI			F-13	P-13		
XCODE			F-13W			
BEY-2D		CAPRI	F-19	P-19		
		CAPRI S.	F-19	P-19		
	NEO-DAKKI	F-19	P-19			
BILMA	BIL-1T	CAPRI	F-8	P-8		
		CAPRI S.	F-8	P-8		FIC-TUB
BKS	ORIGINAL WS 50 NW	CAPRI	F-35W	P-35		AD-BKS
		CAPRI S.	F-35W	P-35		AD-BKS
		NEO-DAKKI	F-35W	P-35		AD-BKS
		XCODE	F-35W			AD-X10
	ORIGINAL WS 50 RA, RK, RZ	XCODE	F-35W			AD-X08
BORKEY	BKY-1	CAPRI	F-1	P-1		
		CAPRI S.	F-1	P-1		
		NEO-DAKKI	F-1	P-1		

						
BORKEY	BKY-1	XCODE	F-5W			
	BKY-2	CAPRI	F-1	P-1		
		CAPRI S.	F-1	P-1		
		NEO-DAKKI	F-1	P-1		
BRAS	BRAS-1	CAPRI	F-13	P-13		
		CAPRI S.	F-13	P-13		
		NEO-DAKKI	F-13	P-13		
BRICARD	BRI-16	CAPRI	F-1	P-1		
		CAPRI S.	F-1	P-1		
		NEO-DAKKI	F-1	P-1		
		XCODE	F-5W			
	BRI-25	CAPRI	F-1	P-1		AD-CI
		CAPRI S.	F-1	P-1		AD-CI
		NEO-DAKKI	F-1	P-1		AD-CI
	BRI-26	CAPRI	F-1	P-1		AD-CI
		NEO-DAKKI	F-1	P-1		AD-CI
		CAPRI S.	F-1	P-1		AD-CI
	BRI-27	CAPRI	F-1	P-1		AD-CI
		CAPRI S.	F-1	P-1		AD-CI
		NEO-DAKKI	F-1	P-1		AD-CI
	BRI-28	CAPRI	F-1	P-1		AD-CI
		CAPRI S.	F-1	P-1		AD-CI
		NEO-DAKKI	F-1	P-1		AD-CI
	BRI-29	CAPRI	F-1	P-1		AD-CI
		CAPRI S.	F-1	P-1		AD-CI
		NEO-DAKKI	F-1	P-1		AD-CI
		XCODE	F-1W			AD-X03
	BRI-30	CAPRI	F-1	P-1		AD-CI
		CAPRI S.	F-1	P-1		AD-CI
		NEO-DAKKI	F-1	P-1		AD-CI
	BRI-31	CAPRI	F-1	P-1		AD-CI
		CAPRI S.	F-1	P-1		AD-CI
		NEO-DAKKI	F-1	P-1		AD-CI
	BRI-33	CAPRI	F-1	P-1		AD-CI
		CAPRI S.	F-1	P-1		AD-CI
		NEO-DAKKI	F-1	P-1		AD-CI
	BRI-34	CAPRI	F-1	P-1		AD-CI
		CAPRI S.	F-1	P-1		AD-CI
NEO-DAKKI		F-1	P-1		AD-CI	
ORIGINAL DUAL XP	XCODE	F-1W				
BRISANT	BRN-1D	NEO-DAKKI	F-19	P-19		





LLAVES DE SEGURIDAD

DIMPLE KEYS

						
BRISANT	BRN-1D	CAPRI	F-19	P-19		
		CAPRI S.	F-19	P-19		
		XCODE	F-19W			
	BRN-2D	NEO-DAKKI	F-19	P-19		
		CAPRI	F-19	P-19		
		CAPRI S.	F-19	P-19		
XCODE		F-19W				
BULAT	BUL-1	NEO-DAKKI	F-1	P-1		
		CAPRI S.	F-1	P-1		
		CAPRI	F-1	P-1		
BURG	BUR-33	NEO-DAKKI	F-1	P-1		
		CAPRI S.	F-1	P-1		
		CAPRI	F-1	P-1		
BYP	BYP-1D	CAPRI	F-19	P-19		
		CAPRI S.	F-19	P-19		
		NEO-DAKKI	F-19	P-19		
CAYS	CAY-2	CAPRI	F-1	P-1		
		CAPRI S.	F-1	P-1		
		NEO-DAKKI	F-1	P-1		
		XCODE	F-19			
CES	CE-114	CAPRI	F-32	P-32		
		CAPRI S.	F-32	P-32		
		NEO-DAKKI	F-32	P-32		
		XCODE	F-32			
	ORIGINAL WSM	CAPRI	F-32	P-32		
		CAPRI S.	F-32	P-32		
		NEO-DAKKI	F-32	P-32		
		XCODE	F-32			
CHICAGO	CHI-1T	CAPRI	F-8	P-8		
		CAPRI S.	F-8	P-8	FIC-TUB	
CHUBB	CHU-10	CAPRI	F-1	P-1		
		CAPRI S.	F-1	P-1		
		NEO-DAKKI	F-1	P-1		
CISA	CI-14	CAPRI	F-1	P-1		
		CAPRI S.	F-1	P-1		
		NEO-DAKKI	F-1	P-1		
		XCODE	F-5W			
		CI-17	CAPRI	F-1	P-1	
			CAPRI S.	F-1	P-1	
	NEO-DAKKI		F-1	P-1		
	XCODE		F-43			
	CI-21	CAPRI	F-1	P-1	AD-CI	

					
CISA	CI-21	CAPRI S.	F-1	P-1	AD-CI
		NEO-DAKKI	F-1	P-1	AD-CI
		XCODE	F-1W		
CI-25	CAPRI	F-1	P-1	AD-CI	
	CAPRI S.	F-1	P-1	AD-CI	
	NEO-DAKKI	F-1	P-1	AD-CI	
	XCODE	F-1W			
CI-26	CAPRI	F-1	P-1	AD-CI	
	CAPRI S.	F-1	P-1	AD-CI	
	NEO-DAKKI	F-1	P-1	AD-CI	
	XCODE	F-1W			
CI-30	CAPRI	F-1	P-1	AD-CI	
	CAPRI S.	F-1	P-1	AD-CI	
	NEO-DAKKI	F-1	P-1	AD-CI	
	XCODE	F-1W			
CI-31	CAPRI	F-1	P-1	AD-CI	
	CAPRI S.	F-1	P-1	AD-CI	
	NEO-DAKKI	F-1	P-1	AD-CI	
	XCODE	F-1W		AD-X03	
CI-32	CAPRI	F-1	P-1	AD-CI	
	NEO-DAKKI	F-1	P-1	AD-CI	
	CAPRI S.	F-1	P-1	AD-CI	
	XCODE	F-1W		AD-X03	
CI-33	CAPRI	F-1	P-1	AD-CI	
	CAPRI S.	F-1	P-1	AD-CI	
	NEO-DAKKI	F-1	P-1	AD-CI	
	XCODE	F-1W			
CI-35	CAPRI	F-1	P-1	AD-CI	
	CAPRI S.	F-1	P-1	AD-CI	
	NEO-DAKKI	F-1	P-1	AD-CI	
	XCODE	F-1W		AD-X03	
CI-48	CAPRI	F-1	P-1	AD-CI	
	CAPRI S.	F-1	P-1	AD-CI	
	NEO-DAKKI	F-1	P-1	AD-CI	
CI-48P	CAPRI	F-1	P-1	AD-CI	
	CAPRI S.	F-1	P-1	AD-CI	
	NEO-DAKKI	F-1	P-1	AD-CI	
CI-56	CAPRI	F-1	P-1	AD-CI	
	CAPRI S.	F-1	P-1	AD-CI	
	NEO-DAKKI	F-1	P-1	AD-CI	
CI-57	CAPRI	F-1	P-1	AD-CI	
	CAPRI S.	F-1	P-1	AD-CI	





®	JMA				
CISA	CI-57	NEO-DAKKI	F-1	P-1	AD-CI
	CI-59	CAPRI	F-1	P-1	
		CAPRI S.	F-1	P-1	
		NEO-DAKKI	F-1	P-1	
	CI-60	CAPRI	F-1	P-1	AD-CI
		CAPRI S.	F-1	P-1	AD-CI
		NEO-DAKKI	F-1	P-1	AD-CI
	CI-66	CAPRI	F-1	P-1	AD-CI
		CAPRI S.	F-1	P-1	AD-CI
		NEO-DAKKI	F-1	P-1	AD-CI
	CI-71	CAPRI	F-1	P-1	AD-CI
		CAPRI S.	F-1	P-1	AD-CI
		NEO-DAKKI	F-1	P-1	AD-CI
	CI-71P	CAPRI	F-1	P-1	AD-CI
		CAPRI S.	F-1	P-1	AD-CI
		NEO-DAKKI	F-1	P-1	AD-CI
	CI-72	CAPRI	F-1	P-1	AD-CI
		CAPRI S.	F-1	P-1	AD-CI
		NEO-DAKKI	F-1	P-1	AD-CI
	CI-72P	CAPRI	F-1	P-1	AD-CI
		CAPRI S.	F-1	P-1	AD-CI
		NEO-DAKKI	F-1	P-1	AD-CI
	CI-73	CAPRI	F-1	P-1	AD-CI
		CAPRI S.	F-1	P-1	AD-CI
		NEO-DAKKI	F-1	P-1	AD-CI
	CI-73P	CAPRI	F-1	P-1	AD-CI
		CAPRI S.	F-1	P-1	AD-CI
		NEO-DAKKI	F-1	P-1	AD-CI
	CI-75P	CAPRI	F-1	P-1	AD-CI
		CAPRI S.	F-1	P-1	AD-CI
		NEO-DAKKI	F-1	P-1	AD-CI
	CI-76P	CAPRI	F-1	P-1	AD-CI
		CAPRI S.	F-1	P-1	AD-CI
		NEO-DAKKI	F-1	P-1	AD-CI
	CI-77P	CAPRI	F-1	P-1	AD-CI
		CAPRI S.	F-1	P-1	AD-CI
NEO-DAKKI		F-1	P-1	AD-CI	
CI-78P	CAPRI	F-1	P-1	AD-CI	
	CAPRI S.	F-1	P-1	AD-CI	
	NEO-DAKKI	F-1	P-1	AD-CI	
CI-79P	CAPRI	F-1	P-1	AD-CI	
	CAPRI S.	F-1	P-1	AD-CI	







®	JMA					
CISA	CI-79P	NEO-DAKKI	F-1	P-1	AD-CI	
	CI-80P	CAPRI	F-1	P-1	AD-CI	
		CAPRI S.	F-1	P-1	AD-CI	
		NEO-DAKKI	F-1	P-1	AD-CI	
	CI-81	CAPRI	F-1	P-1	AD-CI	
		CAPRI S.	F-1	P-1	AD-CI	
		NEO-DAKKI	F-1	P-1	AD-CI	
	CI-81P	CAPRI	F-1	P-1	AD-CI	
		CAPRI S.	F-1	P-1	AD-CI	
		NEO-DAKKI	F-1	P-1	AD-CI	
	CI-82P	CAPRI	F-1	P-1	AD-CI	
		CAPRI S.	F-1	P-1	AD-CI	
		NEO-DAKKI	F-1	P-1	AD-CI	
	CI-82P	CAPRI	F-1	P-1	AD-CI	
		CAPRI S.	F-1	P-1	AD-CI	
		NEO-DAKKI	F-1	P-1	AD-CI	
	CI-83P	CAPRI	F-1	P-1	AD-CI	
		CAPRI S.	F-1	P-1	AD-CI	
		NEO-DAKKI	F-1	P-1	AD-CI	
	CI-83P	CAPRI	F-1	P-1	AD-CI	
		CAPRI S.	F-1	P-1	AD-CI	
		XCODE	F-1W		AD-X03	
	CI-84P	CAPRI	F-1	P-1	AD-CI	
		CAPRI S.	F-1	P-1	AD-CI	
		NEO-DAKKI	F-1	P-1	AD-CI	
	CI-84P	CAPRI	F-1	P-1	AD-CI	
		CAPRI S.	F-1	P-1	AD-CI	
		XCODE	F-1W		AD-X03	
	CORBIN	COR-37	CAPRI	F-5	P-5	
			CAPRI S.	F-5	P-5	
			NEO-DAKKI	F-5	P-5	
		XCODE	F-19			
	COR-77	CAPRI	F-5	P-5		
		CAPRI S.	F-5	P-5		
		NEO-DAKKI	F-5	P-5		
	XCODE	F-19				
ORIGINAL EUROVAL	XCODE	F-5W				
CVL	CVL-9D	CAPRI	F-13	P-13		
		CAPRI S.	F-13	P-13		
		NEO-DAKKI	F-13	P-13		
		NEO-DAKKI	F-13W			
DAF	DAF-2	CAPRI	F-13	P-13		
		CAPRI S.	F-13	P-13		
		NEO-DAKKI	F-13	P-13		
	DAF-3D	CAPRI	F-13	P-13		

LLAVES DE SEGURIDAD

DIMPLE KEYS

						
DAF	DAF-3D	CAPRI S.	F-13	P-13		
		NEO-DAKKI	F-13	P-13		
	DAF-4D	CAPRI	F-13	P-13		
		CAPRI S.	F-13	P-13		
		NEO-DAKKI	F-13	P-13		
	DEKABA	DEK-3	CAPRI	F-1	P-1	
CAPRI S.			F-1	P-1		
NEO-DAKKI			F-1	P-1		
XCODE			F-6			
DEK-4		CAPRI	F-1	P-1		
		CAPRI S.	F-1	P-1		
		NEO-DAKKI	F-1	P-1		
DEK-8		CAPRI	F-1	P-1		
		CAPRI S.	F-1	P-1		
		NEO-DAKKI	F-1	P-1		
		XCODE	F-6			
DEK-11		CAPRI	F-1	P-1		
		CAPRI S.	F-1	P-1		
		NEO-DAKKI	F-1	P-1		
DEK-16		CAPRI	F-1	P-1		
		CAPRI S.	F-1	P-1		
		NEO-DAKKI	F-1	P-1		
DEK-17		CAPRI	F-6	P-6		
		CAPRI S.	F-6	P-6		
		NEO-DAKKI	F-6	P-6		
DELCA		DLC-1	CAPRI	F-1	P-1	
	CAPRI S.		F-1	P-1		
	NEO-DAKKI		F-1	P-1		
	DLC-2	CAPRI	F-1	P-1		
		CAPRI S.	F-1	P-1		
		NEO-DAKKI	F-1	P-1		
DLC-3	CAPRI	F-1	P-1			
	CAPRI S.	F-1	P-1			
	NEO-DAKKI	F-1	P-1			
DIERRE	DR-1	CAPRI	F-33	P-33		
		CAPRI S.	F-33	P-33		
		NEO-DAKKI	F-33	P-33		
	DR-2D	CAPRI	F-13	P-13		
		CAPRI S.	F-13	P-13		
		NEO-DAKKI	F-13	P-13		
DOM	DOM-171	CAPRI	F-1	P-1		
		CAPRI S.	F-1	P-1		

						
DOM	DOM-171	NEO-DAKKI	F-1	P-1		
		XCODE	F-1W			
	DOM-22	CAPRI	F-1	P-1		
		CAPRI S.	F-1	P-1		
		NEO-DAKKI	F-1	P-1		
		XCODE	F-1W			
	DOM-30	CAPRI	F-1	P-1		
		CAPRI S.	F-1	P-1		
		NEO-DAKKI	F-1	P-1		
		XCODE	F-1W			
	DOM-31	CAPRI	F-1	P-1	AD-ST5	
		CAPRI S.	F-1	P-1	AD-ST5	
		NEO-DAKKI	F-1	P-1	AD-ST5	
		XCODE	F-1W			
	DOM-32	CAPRI	F-1	P-1	AD-ST5	
		CAPRI S.	F-1	P-1	AD-ST5	
		NEO-DAKKI	F-1	P-1	AD-ST5	
	DOM-33	CAPRI	F-1	P-1	AD-ST5	
		CAPRI S.	F-1	P-1	AD-ST5	
		NEO-DAKKI	F-1	P-1	AD-ST5	
		XCODE	F-1W			
DOM-34	CAPRI	F-1	P-1	AD-ST5		
	CAPRI S.	F-1	P-1	AD-ST5		
	NEO-DAKKI	F-1	P-1	AD-ST5		
	XCODE	F-1W				
DOM-39	CAPRI	F-1	P-1	AD-ST5		
	CAPRI S.	F-1	P-1	AD-ST5		
	NEO-DAKKI	F-1	P-1	AD-ST5		
	XCODE	F-1W				
DOM-43	CAPRI	F-1	P-1	AD-ST5		
	CAPRI S.	F-1	P-1	AD-ST5		
	NEO-DAKKI	F-1	P-1	AD-ST5		
DOM-56D	CAPRI	F-1	P-1			
	CAPRI S.	F-1	P-1			
	NEO-DAKKI	F-1	P-1			
DOM-63D	CAPRI	F-1	P-1			
	CAPRI S.	F-1	P-1			
	NEO-DAKKI	F-1	P-1			
DOM-B1	CAPRI	F-1	P-1			
	CAPRI S.	F-1	P-1			
	NEO-DAKKI	F-1	P-1			







						
DOM	ORIGINAL IX5 DAS 038	CAPRI	F-1	P-1	AD-DO	
		CAPRI S.	F-1	P-1	AD-DO	
		NEO-DAKKI	F-1	P-1	AD-DO	
		XCODE	F-1W		M4	
	ORIGINAL IX DAS 138	CAPRI	F-23	P-23		
		CAPRI S.	F-23	P-23		
		NEO-DAKKI	F-23	P-23		
		XCODE	F-23W		M1	
	ORIGINAL IX6 KG 102/121	CAPRI	F-1A	P-1	AD-DO	
		CAPRI S.	F-1A	P-1	AD-DO	
		NEO-DAKKI	F-1A	P-1	AD-DO	
		XCODE	F-1A		M4	
	ORIGINAL IX6 SR 132/232	CAPRI	F-23	P-23	AD-DO	
		CAPRI S.	F-23	P-23	AD-DO	
		NEO-DAKKI	F-23	P-23	AD-DO	
		XCODE	F-23W		M4	
DOM-B6	CAPRI	F-1A	P-23	AD-B6		
	CAPRI S.	F-1A	P-23	AD-B6		
	NEO-DAKKI	F-1A	P-23	AD-B6		
DOMUS	DO-3	CAPRI	F-1	P-1		
		CAPRI S.	F-1	P-1		
		NEO-DAKKI	F-1	P-1		
		XCODE	F-43			
	DO-4	CAPRI	F-1	P-1		
		CAPRI S.	F-1	P-1		
NEO-DAKKI		F-1	P-1			
ELZETT	ELZ-10	CAPRI	F-5	P-5		
		CAPRI S.	F-5	P-5		
		NEO-DAKKI	F-5	P-5		
		XCODE	F-5W			
	ELZ-10D	CAPRI	F-5	P-5		
		NEO-DAKKI	F-5	P-5		
		CAPRI S.	F-5	P-5		
	ELZ-13	CAPRI	F-5	P-5		
		NEO-DAKKI	F-5	P-5		
		CAPRI S.	F-5	P-5		
EUROLOCKS	EU-12	CAPRI	F-33	P-33		
		NEO-DAKKI	F-33	P-33		
		CAPRI S.	F-33	P-33		
	EU-15P	CAPRI	F-33	P-33		
		NEO-DAKKI	F-33	P-33		
		CAPRI S.	F-33	P-33		







						
EUROLOCKS	EU-16DP	CAPRI	F-33	P-33		
		NEO-DAKKI	F-33	P-33		
		CAPRI S.	F-33	P-33		
EZCURRA	EZ-DS10	CAPRI	F-1	P-1		
				F-16	P-16	
		CAPRI S.	F-1	P-1		
				F-16	P-16	
		NEO-DAKKI	F-1	P-1		
			F-16	P-16		
		XCODE	F-27			
	EZ-DS10E	CAPRI	F-1	P-1		
				F-16	P-16	
		CAPRI S.	F-1	P-1		
		F-16	P-16			
	NEO-DAKKI	F-1	P-1			
		F-16	P-16			
	XCODE	F-5W				
EZ-DS15	CAPRI	F-1	P-1			
			F-16	P-16		
	CAPRI S.	F-1	P-1			
			F-16	P-16		
	NEO-DAKKI	F-1	P-1			
		F-16	P-16			
EZ-DS15R	CAPRI	F-1	P-1			
			F-16	P-16		
	CAPRI S.	F-1	P-1			
			F-16	P-16		
	NEO-DAKKI	F-1	P-1			
			F-16	P-16		
	XCODE	F-5W				
FAC	FAC-19	CAPRI	F-1	P-1		
		CAPRI S.	F-1	P-1		
		NEO-DAKKI	F-1	P-1		
		XCODE	F-5W			
	FAC-23	CAPRI	F-1	P-1		
		CAPRI S.	F-1	P-1		
		NEO-DAKKI	F-1	P-1		
	XCODE	F-1W				
FAC-24	CAPRI	F-1	P-1			
	CAPRI S.	F-1	P-1			
	NEO-DAKKI	F-1	P-1			
FAC-25	CAPRI	F-1	P-1			

LLAVES DE SEGURIDAD

DIMPLE KEYS

					
FAC	FAC-25	CAPRI S.	F-1	P-1	
		NEO-DAKKI	F-1	P-1	
FAVOUR	FAV-1D	CAPRI	F-5	P-5	
		CAPRI S.	F-5	P-5	
		NEO-DAKKI	F-5	P-5	
		XCODE	F-19		
	FAV-2	CAPRI	F-5	P-5	
		CAPRI S.	F-5	P-5	
FAYN	FAY-1D	CAPRI	F-5	P-5	
		CAPRI S.	F-5	P-5	
		NEO-DAKKI	F-5	P-5	
F-CV	FV-3	CAPRI	F-5	P-5	
		CAPRI S.	F-5	P-5	
		NEO-DAKKI	F-5	P-5	
FERONERIA	FER-2D	CAPRI	F-19	P-19	
		CAPRI S.	F-19	P-19	
		NEO-DAKKI	F-19	P-19	
FF	FF-13	CAPRI	F-13	P-13	
		CAPRI S.	F-13	P-13	
		NEO-DAKKI	F-13	P-13	
FICHET	FIC-2	CAPRI	F-11A	P-11	
		CAPRI S.	F-11A	P-11	FIC-TUB
	FIC-3	CAPRI	F-11A	P-11	
		CAPRI S.	F-11A	P-11	FIC-TUB
	FIC-4	CAPRI	F-11A	P-11	
		CAPRI S.	F-11A	P-11	FIC-TUB
	FIC-18	CAPRI	F-18	P-18	FIC-18-DA
		CAPRI S.	F-18	P-18	FIC-18-DA
FONTAINE	FON-1E	CAPRI	F-8	P-8	
		CAPRI S.	F-8	P-8	FIC-TUB
	FON-2E	CAPRI	F-8	P-8	
		CAPRI S.	F-8	P-8	FIC-TUB
	FON-3E	CAPRI	F-8	P-8	
		CAPRI S.	F-8	P-8	FIC-TUB
	FON-5E	CAPRI	F-8	P-8	
		CAPRI S.	F-8	P-8	FIC-TUB
	FON-6E	CAPRI	F-8	P-8	
		CAPRI S.	F-8	P-8	FIC-TUB
FORD	FO-6P	CAPRI	F-22	P-22	AD-FO
		CAPRI S.	F-22	P-22	AD-FO
		NEO-DAKKI	F-22	P-22	AD-FO

						
FTH	FTH-16	CAPRI	F-5	P-5		
		CAPRI S.	F-5	P-5		
		NEO-DAKKI	F-5	P-5		
		XCODE	F-19			
	FTH-23	CAPRI	F-5	P-5		
		CAPRI S.	F-5	P-5		
		NEO-DAKKI	F-5	P-5		
		XCODE	F-1W			
	FTH-24	CAPRI	F-5	P-5		
		CAPRI S.	F-5	P-5		
		NEO-DAKKI	F-5	P-5		
	FTH-25	CAPRI	F-5	P-5		
		CAPRI S.	F-5	P-5		
		NEO-DAKKI	F-5	P-5		
	FTH-26D	CAPRI	F-5	P-5		
		CAPRI S.	F-5	P-5		
		NEO-DAKKI	F-5	P-5		
	FTH-29	CAPRI	F-5	P-5		
		CAPRI S.	F-5	P-5		
		NEO-DAKKI	F-5	P-5		
	FTH-30	CAPRI	F-5	P-5		
		CAPRI S.	F-5	P-5		
		NEO-DAKKI	F-5	P-5		
	FTH-7	CAPRI	F-5	P-5		
		CAPRI S.	F-5	P-5		
		NEO-DAKKI	F-5	P-5		
		XCODE	F-19			
	G.M.	GM-49DP	CAPRI	F-11	P-11	
			CAPRI S.	F-11	P-11	
			NEO-DAKKI	F-11	P-11	
GERA	ORIGINAL GERA WS / WS XP / PLUS	XCODE	F-13W			
GERDA	GDA-1P	CAPRI	F-1	P-1		
		CAPRI S.	F-1	P-1		
		NEO-DAKKI	F-1	P-1		
GEVY	GEV-3D	CAPRI	F-1	P-1		
		CAPRI S.	F-1	P-1		
		NEO	F-1	P-1		
GIOBERT	GIOB-3P	CAPRI	F-6	P-6		
		CAPRI S.	F-6	P-6		
		NEO-DAKKI	F-6	P-6		

						
GIOBERT	<i>GIOB-3P</i>	<i>NEO-DAKKI</i>	<i>F-6</i>			
GODREJ	<i>GOD-1</i>	<i>CAPRI</i>	<i>F-1</i>	<i>P-1</i>		
		<i>CAPRI S.</i>	<i>F-1</i>	<i>P-1</i>		
		<i>NEO-DAKKI</i>	<i>F-1</i>	<i>P-1</i>		
	<i>GOD-2</i>	<i>CAPRI</i>	<i>F-1</i>	<i>P-1</i>		
		<i>CAPRI S.</i>	<i>F-1</i>	<i>P-1</i>		
		<i>NEO-DAKKI</i>	<i>F-1</i>	<i>P-1</i>		
HB	<i>HB-1</i>	<i>CAPRI</i>	<i>F-13</i>	<i>P-13</i>		
		<i>CAPRI S.</i>	<i>F-13</i>	<i>P-13</i>		
		<i>NEO-DAKKI</i>	<i>F-13</i>	<i>P-13</i>		
HOK	<i>HOK-1D</i>	<i>CAPRI</i>	<i>F-5</i>	<i>P-5</i>		
		<i>CAPRI S.</i>	<i>F-5</i>	<i>P-5</i>		
		<i>NEO-DAKKI</i>	<i>F-5</i>	<i>P-5</i>		
HONDA	<i>HOND-17P</i>	<i>CAPRI</i>	<i>F-11</i>	<i>P-11</i>		
		<i>CAPRI S.</i>	<i>F-11</i>	<i>P-11</i>		
		<i>NEO-DAKKI</i>	<i>F-11</i>	<i>P-11</i>		
		<i>XCODE</i>	<i>F-11W</i>			
	<i>TPOOHOND-31P</i>	<i>CAPRI</i>	<i>F-11</i>	<i>P-11</i>		
		<i>CAPRI S.</i>	<i>F-11</i>	<i>P-11</i>		
		<i>NEO-DAKKI</i>	<i>F-11</i>	<i>P-11</i>		
		<i>XCODE</i>	<i>F-11W</i>			
HTEC	<i>HTE-50</i>	<i>CAPRI</i>	<i>F-5</i>	<i>P-5</i>		
		<i>CAPRI S.</i>	<i>F-5</i>	<i>P-5</i>		
		<i>NEO-DAKKI</i>	<i>F-5</i>	<i>P-5</i>		
HUF	<i>BM-1P</i>	<i>CAPRI</i>	<i>F-1</i>	<i>P-1</i>		
		<i>CAPRI S.</i>	<i>F-1</i>	<i>P-1</i>		
		<i>NEO-DAKKI</i>	<i>F-1</i>	<i>P-1</i>		
	<i>BM-4</i>	<i>CAPRI</i>	<i>F-11</i>	<i>P-11</i>	<i>AD-MJ</i>	
		<i>CAPRI S.</i>	<i>F-11</i>	<i>P-11</i>	<i>AD-MJ</i>	
		<i>NEO-DAKKI</i>	<i>F-11</i>	<i>P-11</i>	<i>AD-MJ</i>	
	<i>BM-5P</i>	<i>CAPRI</i>	<i>F-11</i>	<i>P-11</i>	<i>AD-MJ</i>	
		<i>CAPRI S.</i>	<i>F-11</i>	<i>P-11</i>	<i>AD-MJ</i>	
		<i>NEO-DAKKI</i>	<i>F-11</i>	<i>P-11</i>	<i>AD-MJ</i>	
		<i>XCODE</i>	<i>F-11W</i>			
	<i>BM-6P</i>	<i>CAPRI</i>	<i>F-11</i>	<i>P-11</i>	<i>AD-AUDI</i>	
		<i>CAPRI S.</i>	<i>F-11</i>	<i>P-11</i>	<i>AD-AUDI</i>	
		<i>NEO</i>	<i>F-11</i>	<i>P-11</i>		
		<i>DAKKI</i>	<i>F-11</i>	<i>P-11</i>	<i>AD-AUDI</i>	
		<i>XCODE</i>	<i>F-17W</i>		<i>AD-X06</i>	
	<i>BM-7P</i>	<i>CAPRI</i>	<i>F-33</i>	<i>P-33</i>		
		<i>CAPRI S.</i>	<i>F-33</i>	<i>P-33</i>		
		<i>NEO-DAKKI</i>	<i>F-33</i>	<i>P-33</i>		





						
HUF	<i>BM-7P</i>	<i>XCODE</i>	<i>F-22</i>			
	<i>FO-24P</i>	<i>CAPRI</i>	<i>F-11</i>	<i>P-11</i>		
		<i>CAPRI S.</i>	<i>F-11</i>	<i>P-11</i>		
		<i>NEO-DAKKI</i>	<i>F-11</i>	<i>P-11</i>	<i>AD-F024</i>	
		<i>XCODE</i>	<i>F-11W</i>			
	<i>FO-24C3</i>	<i>CAPRI</i>	<i>F-11</i>	<i>P-11</i>		
		<i>CAPRI S.</i>	<i>F-11</i>	<i>P-11</i>		
		<i>NEO-DAKKI</i>	<i>F-11</i>	<i>P-11</i>	<i>AD-F024</i>	
		<i>XCODE</i>	<i>F-11W</i>			
	<i>FO-24C8</i>	<i>CAPRI</i>	<i>F-11</i>	<i>P-11</i>		
		<i>CAPRI S.</i>	<i>F-11</i>	<i>P-11</i>		
		<i>NEO-DAKKI</i>	<i>F-11</i>	<i>P-11</i>	<i>AD-F024</i>	
		<i>XCODE</i>	<i>F-11W</i>			
	<i>FO-24C9</i>	<i>CAPRI</i>	<i>F-11</i>	<i>P-11</i>		
		<i>CAPRI S.</i>	<i>F-11</i>	<i>P-11</i>		
		<i>NEO-DAKKI</i>	<i>F-11</i>	<i>P-11</i>	<i>AD-F024</i>	
		<i>XCODE</i>	<i>F-11W</i>			
	<i>HU-2P</i>	<i>CAPRI</i>	<i>F-11</i>	<i>P-11</i>		
		<i>CAPRI S.</i>	<i>F-11</i>	<i>P-11</i>		
		<i>NEO-DAKKI</i>	<i>F-11</i>	<i>P-11</i>		
<i>XCODE</i>		<i>F-11W</i>				
<i>HU-2P-1</i>	<i>CAPRI</i>	<i>F-11</i>	<i>P-11</i>			
	<i>CAPRI S.</i>	<i>F-11</i>	<i>P-11</i>			
	<i>NEO-DAKKI</i>	<i>F-11</i>	<i>P-11</i>			
<i>HU-4C1</i>	<i>CAPRI</i>	<i>F-11</i>	<i>P-11</i>			
	<i>CAPRI S.</i>	<i>F-11</i>	<i>P-11</i>			
	<i>NEO-DAKKI</i>	<i>F-11</i>	<i>P-11</i>			
<i>HU-DHP</i>	<i>CAPRI</i>	<i>F-11</i>	<i>P-11</i>			
	<i>CAPRI S.</i>	<i>F-11</i>	<i>P-11</i>			
	<i>NEO-DAKKI</i>	<i>F-11</i>	<i>P-11</i>			
	<i>XCODE</i>	<i>F-11W</i>				
<i>HU-DHP1</i>	<i>CAPRI</i>	<i>F-11</i>	<i>P-11</i>			
	<i>CAPRI S.</i>	<i>F-11</i>	<i>P-11</i>			
	<i>NEO-DAKKI</i>	<i>F-11</i>	<i>P-11</i>			
	<i>XCODE</i>	<i>F-11W</i>				
<i>HU-DHP2</i>	<i>CAPRI</i>	<i>F-11</i>	<i>P-11</i>			
	<i>CAPRI S.</i>	<i>F-11</i>	<i>P-11</i>			
	<i>NEO-DAKKI</i>	<i>F-11</i>	<i>P-11</i>			
	<i>XCODE</i>	<i>F-11W</i>				
<i>HU-DHP3</i>	<i>CAPRI</i>	<i>F-11</i>	<i>P-11</i>			
	<i>CAPRI S.</i>	<i>F-11</i>	<i>P-11</i>			
	<i>NEO-DAKKI</i>	<i>F-11</i>	<i>P-11</i>			

LLAVES DE SEGURIDAD

DIMPLE KEYS

						
HUF	HU-DHP3	XCODE	F-11W			
	HU-DNP	CAPRI	F-11	P-11		
		CAPRI S.	F-11	P-11		
		NEO-DAKKI	F-11	P-11		
		XCODE	F-11W			
	HU-HAAP	CAPRI	F-11	P-11	AD-AUDI	
		CAPRI S.	F-11	P-11	AD-AUDI	
		NEO	F-11	P-11		
		DAKKI	F-11	P-11	AD-AUDI	
		XCODE	F-17W		AD-AU	
	HU-HAAP1	CAPRI	F-11	P-11	AD-AUDI	
		CAPRI S.	F-11	P-11	AD-AUDI	
		NEO	F-11	P-11		
		DAKKI	F-11	P-11	AD-AUDI	
		XCODE	F-17W		AD-AU	
	HU-HCAP	CAPRI	F-11	P-11		
		CAPRI S.	F-11	P-11		
		NEO-DAKKI	F-11	P-11		
		XCODE	F-17W			
	ME-2P	CAPRI	F-11	P-11	AD-MJ	
		CAPRI S.	F-11	P-11	AD-MJ	
		NEO - DAKKI	F-11	P-11	AD-MJ	
		XCODE	F-11W			
	ME-3P	CAPRI	F-11	P-11	AD-MJ	
		CAPRI S.	F-11	P-11	AD-MJ	
		NEO - DAKKI	F-11	P-11	AD-MJ	
		XCODE	F-11W			
	ME-4P	CAPRI	F-11	P-11	AD-MM	
		CAPRI S.	F-11	P-11	AD-MM	
		NEO	F-11	P-11		
		DAKKI	F-11	P-11	AD-MM	
		XCODE	F-11W		AD-X04	
	ME-5P	CAPRI	F-11	P-11	AD-MM	
		CAPRI S.	F-11	P-11	AD-MM	
		NEO	F-11	P-11		
		DAKKI	F-11	P-11	AD-MM	
		XCODE	F-11W		AD-X04	
	ME-6P	CAPRI	F-11	P-11	AD-MM	
		CAPRI S.	F-11	P-11	AD-MM	
		NEO	F-11	P-11		
		DAKKI	F-11	P-11	AD-MM	
ME-7P	CAPRI	F-11	P-11	AD-MM		

						
HUF	ME-7P	CAPRI S.	F-11	P-11	AD-MM	
		NEO	F-11	P-11		
		DAKKI	F-11	P-11	AD-MM	
		XCODE	F-11W		AD-X04	
	ME-8P	CAPRI	F-11	P-11	AD-MM	
		CAPRI S.	F-11	P-11	AD-MM	
		NEO	F-11	P-11		
		DAKKI	F-11	P-11	AD-MM	
	ME-10P	CAPRI	F-11	P-11	AD-MM	
		CAPRI S.	F-11	P-11	AD-MM	
		NEO	F-11	P-11		
		DAKKI	F-11	P-11	AD-MM	
	ME-11P	CAPRI	F-11	P-11	AD-MM	
		CAPRI S.	F-11	P-11	AD-MM	
		NEO	F-11	P-11		
		DAKKI	F-11	P-11	AD-MM	
	ME-12P	CAPRI	F-11	P-11	AD-MM	
		CAPRI S.	F-11	P-11	AD-MM	
		NEO	F-11	P-11		
		DAKKI	F-11	P-11	AD-MM	
	OP-11C1	CAPRI	F-11	P-11		
		CAPRI S.	F-11	P-11		
		NEO-DAKKI	F-11	P-11		
		XCODE	F-11W			
	OP-11P1	CAPRI	F-11	P-11		
		CAPRI S.	F-11	P-11		
		NEO-DAKKI	F-11	P-11		
		XCODE	F-17W			
	OP-11C3	CAPRI	F-11	P-11		
		CAPRI S.	F-11	P-11		
		NEO-DAKKI	F-11	P-11		
		XCODE	F-17W			
OP-WHP	NEO-DAKKI	F-11	P-11	AD-OP		
	CAPRI	F-11	P-11	AD-OP		
	CAPRI S.	F-11	P-11	AD-OP		
	XCODE	F-11W				
OP-WHC	NEO-DAKKI	F-11	P-11	AD-OP		
	CAPRI	F-11	P-11	AD-OP		
	CAPRI S.	F-11	P-11	AD-OP		
	XCODE	F-11W				

						
HUF	<i>OP-WYP</i>	<i>CAPRI</i>	<i>F-11</i>	<i>P-11</i>	<i>AD-OP</i>	
		<i>CAPRI S.</i>	<i>F-11</i>	<i>P-11</i>	<i>AD-OP</i>	
		<i>NEO-DAKKI</i>	<i>F-11</i>	<i>P-11</i>	<i>AD-OP</i>	
		<i>XCODE</i>	<i>F-11W</i>			
HYUNDAI	<i>HY-18P</i>	<i>CAPRI</i>	<i>F-11</i>	<i>P-11</i>		
		<i>CAPRI S.</i>	<i>F-11</i>	<i>P-11</i>		
		<i>NEO-DAKKI</i>	<i>F-11</i>	<i>P-11</i>		
	<i>HY-18P1C1</i>	<i>CAPRI</i>	<i>F-11</i>	<i>P-11</i>		
		<i>CAPRI S.</i>	<i>F-11</i>	<i>P-11</i>		
		<i>NEO-DAKKI</i>	<i>F-11</i>	<i>P-11</i>		
	<i>HY-19P</i>	<i>CAPRI</i>	<i>F-11</i>	<i>P-11</i>		
		<i>CAPRI S.</i>	<i>F-11</i>	<i>P-11</i>		
		<i>NEO-DAKKI</i>	<i>F-11</i>	<i>P-11</i>		
	<i>HY-19P5</i>	<i>CAPRI</i>	<i>F-11</i>	<i>P-11</i>		
		<i>CAPRI S.</i>	<i>F-11</i>	<i>P-11</i>		
		<i>NEO-DAKKI</i>	<i>F-11</i>	<i>P-11</i>		
IFAM	<i>IF-2</i>	<i>CAPRI</i>	<i>F-1</i>	<i>P-1</i>		
		<i>CAPRI S.</i>	<i>F-1</i>	<i>P-1</i>		
		<i>NEO-DAKKI</i>	<i>F-1</i>	<i>P-1</i>		
		<i>XCODE</i>	<i>F-5W</i>			
	<i>IF-4</i>	<i>CAPRI</i>	<i>F-1</i>	<i>P-1</i>		
		<i>CAPRI S.</i>	<i>F-1</i>	<i>P-1</i>		
		<i>NEO-DAKKI</i>	<i>F-1</i>	<i>P-1</i>		
		<i>XCODE</i>	<i>F-5W</i>			
	<i>IF-6</i>	<i>CAPRI</i>	<i>F-19</i>	<i>P-19</i>		
		<i>CAPRI S.</i>	<i>F-19</i>	<i>P-19</i>		
		<i>NEO-DAKKI</i>	<i>F-19</i>	<i>P-19</i>		
		<i>XCODE</i>	<i>F-19</i>			
<i>IF-8</i>	<i>CAPRI</i>	<i>F-19</i>	<i>P-19</i>			
	<i>CAPRI S.</i>	<i>F-19</i>	<i>P-19</i>			
	<i>NEO</i>	<i>F-19</i>	<i>P-19</i>			
	<i>X-CODE</i>	<i>F-19</i>				
INCECA	<i>INCE-1E</i>	<i>CAPRI</i>	<i>F-8</i>	<i>P-8</i>		
		<i>CAPRI S.</i>	<i>F-8</i>	<i>P-8</i>	<i>FIC-TUB</i>	
IR	<i>IR-1P</i>	<i>CAPRI</i>	<i>F-1</i>	<i>P-1</i>		
		<i>CAPRI S.</i>	<i>F-1</i>	<i>P-1</i>		
		<i>NEO-DAKKI</i>	<i>F-1</i>	<i>P-1</i>		
ISEO	<i>IS-10</i>	<i>NEO-DAKKI</i>	<i>F-1</i>	<i>P-1</i>		
		<i>CAPRI</i>	<i>F-1</i>	<i>P-1</i>		
		<i>CAPRI S.</i>	<i>F-1</i>	<i>P-1</i>		
		<i>IS-10P</i>	<i>NEO-DAKKI</i>	<i>F-1</i>	<i>P-1</i>	
		<i>CAPRI</i>	<i>F-1</i>	<i>P-1</i>		







						
ISEO	<i>IS-10P</i>	<i>CAPRI S.</i>	<i>F-1</i>	<i>P-1</i>		
		<i>XCODE</i>	<i>F-1W</i>			
	<i>IS-14D</i>	<i>CAPRI</i>	<i>F-1</i>	<i>P-1</i>		
		<i>CAPRI S.</i>	<i>F-1</i>	<i>P-1</i>		
		<i>NEO-DAKKI</i>	<i>F-1</i>	<i>P-1</i>		
	<i>IS-20</i>	<i>CAPRI</i>	<i>F-1</i>	<i>P-1</i>		
		<i>CAPRI S.</i>	<i>F-1</i>	<i>P-1</i>		
		<i>NEO-DAKKI</i>	<i>F-1</i>	<i>P-1</i>		
	<i>IS-6D</i>	<i>CAPRI</i>	<i>F-1</i>	<i>P-1</i>		
		<i>CAPRI S.</i>	<i>F-1</i>	<i>P-1</i>		
<i>NEO-DAKKI</i>		<i>F-1</i>	<i>P-1</i>			
<i>XCODE</i>		<i>F-1W</i>				
ITO	<i>ITO-2D</i>	<i>CAPRI</i>	<i>F-1</i>	<i>P-1</i>		
		<i>CAPRI S.</i>	<i>F-1</i>	<i>P-1</i>		
		<i>NEO-DAKKI</i>	<i>F-1</i>	<i>P-1</i>		
	<i>ITO-3D</i>	<i>CAPRI</i>	<i>F-1</i>	<i>P-1</i>		
		<i>CAPRI S.</i>	<i>F-1</i>	<i>P-1</i>		
		<i>NEO-DAKKI</i>	<i>F-1</i>	<i>P-1</i>		
<i>ITO-2D</i>	<i>NEO-DAKKI</i>		<i>F-1</i>	<i>P-1</i>		
JARDI	<i>JAR-1E</i>	<i>CAPRI</i>	<i>F-14</i>	<i>P-14</i>	<i>AD-JAR1E</i>	
		<i>CAPRI S.</i>	<i>F-14</i>	<i>P-14</i>	<i>AD-JAR1E</i>	
		<i>NEO-DAKKI</i>	<i>F-14</i>	<i>P-14</i>	<i>AD-JAR1E</i>	
JIS	<i>JIS-4P</i>	<i>CAPRI</i>	<i>F-11</i>	<i>P-11</i>	<i>AD-JIS</i>	
		<i>CAPRI S.</i>	<i>F-11</i>	<i>P-11</i>	<i>AD-JIS</i>	
		<i>NEO-DAKKI</i>	<i>F-11</i>	<i>P-11</i>	<i>AD-JIS</i>	
JPM	<i>JPM-1E</i>	<i>CAPRI</i>	<i>F-8</i>	<i>P-8</i>		
		<i>CAPRI S.</i>	<i>F-8</i>	<i>P-8</i>	<i>FIC-TUB</i>	
	<i>JPM-2E</i>	<i>CAPRI</i>	<i>F-8</i>	<i>P-8</i>		
		<i>CAPRI S.</i>	<i>F-8</i>	<i>P-8</i>	<i>FIC-TUB</i>	
KABA	<i>KA-1</i>	<i>CAPRI</i>	<i>F-1</i>	<i>P-1</i>		
		<i>CAPRI S.</i>	<i>F-1</i>	<i>P-1</i>		
		<i>NEO-DAKKI</i>	<i>F-1</i>	<i>P-1</i>		
		<i>XCODE</i>	<i>F-27</i>			
	<i>KA-2</i>	<i>CAPRI</i>	<i>F-43</i>	<i>P-43</i>	<i>45°</i>	
		<i>CAPRI</i>	<i>F-5</i>	<i>P-5</i>	<i>45°</i>	
	<i>NEO-DAKKI</i>	<i>F-43</i>	<i>P-43</i>	<i>AD-45°</i>		
	<i>NEO-DAKKI</i>	<i>F-5</i>	<i>P-5</i>	<i>AD-45°</i>		
	<i>CAPRI S.</i>	<i>F-43</i>	<i>P-43</i>	<i>AD-45°</i>		
	<i>CAPRI S.</i>	<i>F-5</i>	<i>P-5</i>	<i>AD-45°</i>		
<i>KA-3</i>	<i>CAPRI</i>	<i>F-1</i>	<i>P-1</i>	<i>15°</i>		
	<i>CAPRI S.</i>	<i>F-1</i>	<i>P-1</i>	<i>AD-15°</i>		
	<i>NEO-DAKKI</i>	<i>F-1</i>	<i>P-1</i>	<i>AD-15°</i>		







LLAVES DE SEGURIDAD

DIMPLE KEYS

							
KABA	KA-3	XCODE	F-27			AD+15	
	KA-4	CAPRI	F-1	P-26			15°
		CAPRI	F-1	P-26			45°
		CAPRI S.	F-1	P-26			AD-15°
		CAPRI S.	F-1	P-26			AD-45°
		NEO-DAKKI	F-1	P-26			AD-15°
		NEO-DAKKI	F-1	P-26			AD-45°
		KA-5	CAPRI	F-4	P-4		
	CAPRI S.		F-4	P-4			
	NEO-DAKKI		F-4	P-4			
	XCODE		F-4				
	KA-6	CAPRI	F-1	P-1			
		CAPRI S.	F-1	P-1			
		NEO-DAKKI	F-1	P-1			
		XCODE	F-43				
	KA-7	CAPRI	F-1	P-1			
		CAPRI S.	F-1	P-1			
		NEO-DAKKI	F-1	P-1			
		XCODE	F-27				
	KA-8	CAPRI	F-1	P-1			
		CAPRI S.	F-1	P-1			
		NEO-DAKKI	F-1	P-1			
	KA-10	CAPRI	F-1	P-1			
		CAPRI S.	F-1	P-1			
		NEO-DAKKI	F-1	P-1			
		XCODE	F-1W				
	KA-11	CAPRI	F-1	P-1			
		CAPRI S.	F-1	P-1			
NEO-DAKKI		F-1	P-1				
KALE	KAE-1	CAPRI	F-1	P-1			
		CAPRI S.	F-1	P-1			
		NEO-DAKKI	F-1	P-1			
		XCODE	F-5W				
	KAE-2	CAPRI	F-1	P-1			
CAPRI S.		F-1	P-1				
NEO-DAKKI		F-1	P-1				
KAE-4	NEO-DAKKI	F-1	P-1				
	CAPRI	F-1	P-1				
	CAPRI S.	F-1	P-1				
KAE-10D	CAPRI	F-1	P-1				
	CAPRI S.	F-1	P-1				
		NEO-DAKKI	F-1	P-1			







							
KALE	KAE-11D	CAPRI	F-1	P-1			
		CAPRI S.	F-1	P-1			
		NEO-DAKKI	F-1	P-1			
		XCODE	F-13W				
	KAE-12D	CAPRI	F-13	P-13			
		CAPRI S.	F-13	P-13			
		NEO-DAKKI	F-13	P-13			
	KAE-14	CAPRI	F-1	P-1			
		CAPRI S.	F-1	P-1			
		NEO-DAKKI	F-1	P-1			
	KESO	KE-1	CAPRI	F-1	P-1	5°	
				F-1	P-1	ADPL-5°	
			CAPRI S.	F-1	P-1	ADPL-5°	
				F-1	P-1	AD-5°	
NEO-DAKKI			F-1	P-1	AD-5°		
		F-1	P-1	ADPL-5°			
		XCODE	F-1W		AD-5°		
			F-1W		ADPL-5°		
KE-3		CAPRI	F-5	P-5			
			F-S31	PS31			
	CAPRI S.	F-5	P-5				
		F-S31	PS31				
	NEO-DAKKI	F-5	P-5				
	XCODE	F-5W					
		F-S31					
KE-4	CAPRI	F-5	P-5				
		F-S31	PS31				
	CAPRI S.	F-5	P-5				
		F-S31	PS31				
	NEO-DAKKI	F-5	P-5				
		F-S31	PS31				
	XCODE	F-5W					
		F-S31					
KE-5	CAPRI	F-1	P-1				
	CAPRI S.	F-1	P-1				
	NEO-DAKKI	F-1	P-1				
KE-6	CAPRI	F-1	P-1				
	CAPRI S.	F-1	P-1				
	NEO-DAKKI	F-1	P-1				
	XCODE	F-49W					
KIA	KI-7P	CAPRI	F-11	P-11			
		CAPRI S.	F-11	P-11			





						
KIA	KI-7P	NEO-DAKKI	F-11	P-11		
		XCODE	F-11W			
	KI-9P	CAPRI	F-11	P-11		
		CAPRI S.	F-11	P-11		
		NEO-DAKKI	F-11	P-11		
	KI-11P	CAPRI	F-11	P-11		
		CAPRI S.	F-11	P-11		
		NEO-DAKKI	F-11	P-11		
	KI-12P	CAPRI	F-11	P-11		
		CAPRI S.	F-11	P-11		
		NEO-DAKKI	F-11	P-11		
	KI-12DP	CAPRI	F-11	P-11		
CAPRI S.		F-11	P-11			
NEO-DAKKI		F-11	P-11			
KTM	KM-1P	CAPRI	F-11	P-11		
		CAPRI S.	F-11	P-11		
		NEO-DAKKI	F-11	P-11		
LAPERCHE	LAP-1E	CAPRI	F-8	P-8		
		CAPRI S.	F-8	P-8		FIC-TUB
	LAP-10D	CAPRI	F-13	P-13		
		CAPRI S.	F-13	P-13		
		NEO-DAKKI	F-13	P-13		
	LAP-11D	CAPRI	F-13	P-13		
		CAPRI S.	F-13	P-13		
		NEO-DAKKI	F-13	P-13		
	LAP-13P	CAPRI	F-13	P-13		
		CAPRI S.	F-13	P-13		
		NEO-DAKKI	F-13	P-13		
		XCODE	F-27			
	LAP-17P	CAPRI	F-13	P-13		
		CAPRI S.	F-13	P-13		
		NEO-DAKKI	F-13	P-13		
		XCODE	F-27			
	LAP-2E	CAPRI	F-8	P-8		
		CAPRI S.	F-8	P-8		FIC-TUB
LAP-4	CAPRI	F-13	P-13			
	CAPRI S.	F-13	P-13			
	NEO-DAKKI	F-13	P-13			
XCODE	F-5W					
	LAP-8D	CAPRI	F-13	P-13		
CAPRI S.		F-13	P-13			
NEO-DAKKI		F-13	P-13			

						
LAPERCHE	LAP-20P	CAPRI	F-13	P-13		
		CAPRI S.	F-13	P-13		
		NEO-DAKKI	F-13	P-13		
		XCODE	F-27			
	LAP-21P	CAPRI	F-13	P-13		
		CAPRI S.	F-13	P-13		
		NEO-DAKKI	F-13	P-13		
		XCODE	F-27			
	LAP-22P	CAPRI	F-13	P-13		
		CAPRI S.	F-13	P-13		
		NEO-DAKKI	F-13	P-13		
		XCODE	F-27			
LAP-23P	CAPRI	F-13	P-13			
	CAPRI S.	F-13	P-13			
	NEO-DAKKI	F-13	P-13			
	XCODE	F-27				
LINCE	LIN-13	CAPRI	F-5	P-5		
		CAPRI S.	F-5	P-5		
		NEO-DAKKI	F-5	P-5		
		XCODE	F-5W			
	LIN-19D	CAPRI	F-5	P-5		
		CAPRI S.	F-5	P-5		
		NEO-DAKKI	F-5	P-5		
		XCODE	F-5W			
	LIN-21D	CAPRI	F-5	P-5		
		CAPRI S.	F-5	P-5		
		NEO-DAKKI	F-5	P-5		
		XCODE	F-5W			
ORIGINAL C-2/C-3/C-4	XCODE	F-5W			M7	
ORIGINAL C-5	XCODE	F-28W			M7	
LIN-26D	CAPRI	F-5	P-5			
	CAPRI S.	F-5	P-5			
	NEO-DAKKI	F-5	P-5			
	XCODE	F-5W				
LYF	LYF-1T	CAPRI	F-8	P-8		
		CAPRI S.	F-8	P-8		FIC-TUB
LYF-2T	CAPRI	F-8	P-8			
	CAPRI S.	F-8	P-8		FIC-TUB	
MAGNUM	MAG-2DP	CAPRI	F-19	P-19		14°
		CAPRI	F-3	P3		
MASTER	MAS-15P	CAPRI	F-6	P-6		
		CAPRI S.	F-6	P-6		





LLAVES DE SEGURIDAD

DIMPLE KEYS

					
MASTER	MAS-15P	NEO-DAKKI	F-6	P-6	
		XCODE	F-6		
MASTER LOCK	MASL-1	CAPRI	F-1	P-1	
		CAPRI S.	F-1	P-1	
		NEO-DAKKI	F-1	P-1	
MAUER	ORIGINAL NVW4	CAPRI	F-13	P-13	10°
		XCODE	F-13W		AD-X11
	MAU-1	NEO-DAKKI	F-1	P-1	
		CAPRI	F-1	P-1	
	MAU-2	NEO-DAKKI	F-1	P-1	
		CAPRI	F-1	P-1	
MAZDA	MAZ-12P1	CAPRI	F-11	P-11	
		CAPRI S.	F-11	P-11	
		NEO-DAKKI	F-11	P-11	
MCM	MCM-10	CAPRI	F-13	P-13	
		CAPRI S.	F-13	P-13	
		NEO-DAKKI	F-13	P-13	AD-MCM
		XCODE	F-13W		AD-X05
	MCM-15E8	CAPRI	F-1	P-1	
		CAPRI S.	F-1	P-1	
		NEO-DAKKI	F-1	P-1	
	MCM-10	XCODE	F-1W		
	MCM-16	CAPRI	F-13	P-13	
		CAPRI S.	F-13	P-13	
		NEO-DAKKI	F-13	P-13	
		XCODE	F-13W		
	MCM-21D	CAPRI	F-13	P-13	
		CAPRI S.	F-13	P-13	
		NEO-DAKKI	F-13	P-13	
	MCM-27	CAPRI	F-13	P-13	
		CAPRI S.	F-13	P-13	
NEO-DAKKI		F-13	P-13		
MCM-4SS	CAPRI	F-1	P-1		
	CAPRI	F-B	PB		
	CAPRI	F-C	PC		
	CAPRI S.	F-1	P-1		
	CAPRI S.	F-B	PB		
	CAPRI S.	F-C	PC		
	NEO-DAKKI	F-C	PC		
	NEO-DAKKI	F-1	P-1		







					
MCM	MCM-4SS	NEO-DAKKI	F-B	PB	
MERONI	MER-1T	CAPRI	F-8	P-8	
		CAPRI S.	F-8	P-8	FIC-TUB
	MER-3T	CAPRI	F-8	P-8	
		CAPRI S.	F-8	P-8	FIC-TUB
MG MONTI	MGA-2	CAPRI	F-1	P-1	
		CAPRI S.	F-1	P-1	
		NEO-DAKKI	F-1	P-1	
MHA	MH-1	CAPRI	F-5	P-5	
		CAPRI S.	F-5	P-5	
		NEO-DAKKI	F-5	P-5	
MLM	MLM-4	CAPRI	F-1	P-1	
		CAPRI S.	F-1	P-1	
		NEO-DAKKI	F-1	P-1	
	MLM-8	CAPRI	F-3	P-3	
		CAPRI S.	F-3	P-3	
		NEO-DAKKI	F-3	P-3	
MOTTURA	MT-2D	CAPRI	F-5	P-5	
		CAPRI S.	F-5	P-5	
		NEO-DAKKI	F-5	P-5	
	MT-1P	CAPRI	F-1	P-1	
		CAPRI S.	F-1	P-1	
		NEO-DAKKI	F-1	P-1	
XCODE	F-27W				
MSM	MSM-1	CAPRI	F-19	P-19	
		CAPRI S.	F-19	P-19	
		NEO-DAKKI	F-19	P-19	
MUL.T.LOCK	MUL-T2P	CAPRI	F-12A	P-12A	
		CAPRI	F-12B	P-12B	
		CAPRI S.	F-12A	P-12A	
		CAPRI S.	F-12B	P-12B	
		NEO-DAKKI	F-12A	P-12A	
		NEO-DAKKI	F-12B	P-12B	
	XCODE	F-12A			
	XCODE	F-12B	P-12X		
	MUL-T3P1	CAPRI	F-12A	P-12A	
		CAPRI	F-12B	P-12B	
		CAPRI S.	F-12A	P-12A	
		CAPRI S.	F-12B	P-12B	
NEO-DAKKI		F-12A	P-12A		
NEO-DAKKI		F-12B	P-12B		
XCODE	F-12A				



®	JMA				
MULT.LOCK	MUL-T3P1	XCODE	F-12B	P-12X	
	MUL-T3PL	CAPRI	F-12A	P-12A	
		CAPRI	F-12B	P-12B	
		CAPRI S.	F-12A	P-12A	
		CAPRI S.	F-12B	P-12B	
		NEO-DAKKI	F-12A	P-12A	
		NEO-DAKKI	F-12B	P-12B	
		XCODE	F-12A	P-12A	
	MUL-T4P	CAPRI	F-12A	P-12A	
		CAPRI	F-12B	P-12B	
		CAPRI S.	F-12A	P-12A	
		CAPRI S.	F-12B	P-12B	
		NEO-DAKKI	F-12A	P-12A	
		NEO-DAKKI	F-12B	P-12B	
		XCODE	F-12A	P-12A	
	MUL-T5P	CAPRI	F-12A	P-12A	
		CAPRI	F-12B	P-12B	
		CAPRI S.	F-12A	P-12A	
		CAPRI S.	F-12B	P-12B	
		NEO-DAKKI	F-12A	P-12A	
		NEO-DAKKI	F-12B	P-12B	
		XCODE	F-12A	P-12A	
	MUL-T7P	CAPRI	F-12A	P-12A	
		CAPRI	F-12B	P-12B	
		CAPRI S.	F-12A	P-12A	
		CAPRI S.	F-12B	P-12B	
		NEO-DAKKI	F-12A	P-12A	
		NEO-DAKKI	F-12B	P-12B	
		XCODE	F-12A	P-12A	
	MUL-T8P1	CAPRI	F-12A	P-12A	
		CAPRI	F-12B	P-12B	
		CAPRI S.	F-12A	P-12A	
		CAPRI S.	F-12B	P-12B	
		NEO-DAKKI	F-12A	P-12A	
		NEO-DAKKI	F-12B	P-12B	
		XCODE	F-12A	P-12A	
	MUL-T9P1	CAPRI	F-12A	P-12A	
		CAPRI	F-12B	P-12B	
		CAPRI S.	F-12A	P-12A	
		CAPRI S.	F-12B	P-12B	
		NEO-DAKKI	F-12A	P-12A	
		NEO-DAKKI	F-12B	P-12B	
MUL-T10P	CAPRI	F-1	P-1		

®	JMA					
MULT.LOCK	MUL-T10P	CAPRI S.	F-1	P-1		
		NEO-DAKKI	F-1	P-1		
		XCODE	F-1W			
	MUL-T11P1	CAPRI	F-12A	P-12A		
		CAPRI	F-12B	P-12B		
		CAPRI S.	F-12A	P-12A		
		CAPRI S.	F-12B	P-12B		
		NEO-DAKKI	F-12A	P-12A		
		NEO-DAKKI	F-12B	P-12B		
	MUL-T16P	CAPRI	F-12A	P-12A		
		CAPRI	F-12B	P-12B		
		CAPRI S.	F-12A	P-12A		
		CAPRI S.	F-12B	P-12B		
		NEO-DAKKI	F-12A	P-12A		
		NEO-DAKKI	F-12B	P-12B		
	ORIGINAL MT5	XCODE	F-12A			
		XCODE	F-12B	P-12X		
	ORIGINAL INTERACTIVE L / R	XCODE	F-12A			
		XCODE	F-12B	P-12X		
	NEIMAN	NE-40	CAPRI	F-11	P-11	
			CAPRI S.	F-11	P-11	
			NEO-DAKKI	F-11	P-11	
XCODE			F-11W			
NE-40P-1		CAPRI	F-11	P-11		
		CAPRI S.	F-11	P-11		
		NEO-DAKKI	F-11	P-11		
		XCODE	F-11W			
NE-41P		CAPRI	F-11	P-11		
		CAPRI S.	F-11	P-11		
		NEO-DAKKI	F-11	P-11		
		XCODE	F-11W			
NE-51P2		CAPRI	F-11	P-11		
		CAPRI S.	F-11	P-11		
		NEO-DAKKI	F-11	P-11		
	XCODE	F-11W				
OJMAR	OJ-Q	CAPRI	F-5	P-5		
		CAPRI S.	F-5	P-5		
		NEO-DAKKI	F-5	P-5		
	OJ-20/4	CAPRI	F-1	P-1		
		CAPRI S.	F-1	P-1		
		NEO-DAKKI	F-1	P-1		
		XCODE	F-29W			

LLAVES DE SEGURIDAD

DIMPLE KEYS

					
OMEC	OMC-3	CAPRI	F-1	P-1	
		CAPRI S.	F-1	P-1	
		NEO-DAKKI	F-1	P-1	
		XCODE	F-1W		
	OMC-4	CAPRI	F-1	P-1	
		CAPRI S.	F-1	P-1	
		NEO-DAKKI	F-1	P-1	
		XCODE	F-1W		
	OMC-7	CAPRI	F-1	P-1	
		CAPRI S.	F-1	P-1	
		NEO-DAKKI	F-1	P-1	
	P&C I.	PCI-1T	CAPRI	F-8	P-8
CAPRI S.			F-8	P-8	FIC-TUB
P.C.	PC-1T	CAPRI	F-8	P-8	
		CAPRI S.	F-8	P-8	FIC-TUB
	PC-3TP	CAPRI	F-8	P-8	
		CAPRI S.	F-8	P-8	FIC-TUB
PENZMASH	PEN-2	CAPRI	F-1	P-1	
		CAPRI S.	F-1	P-1	
		NEO-DAKKI	F-1	P-1	
PFAFFEN-HAIN	PFA-13D	CAPRI	F-34	P-34	AD-PFA
		CAPRI S.	F-34	P-34	AD-PFA
		NEO-DAKKI	F-34	P-34	AD-PFA
	PFA-14D	CAPRI	F-34	P-34	AD-PFA
		CAPRI S.	F-34	P-34	AD-PFA
		NEO-DAKKI	F-34	P-34	AD-PFA
	PFA-15D	CAPRI	F-34	P-34	AD-PFA
		CAPRI S.	F-34	P-34	AD-PFA
		NEO-DAKKI	F-34	P-34	AD-PFA
	PFA-16D	CAPRI	F-34	P-34	AD-PFA
		CAPRI S.	F-34	P-34	AD-PFA
		NEO-DAKKI	F-34	P-34	AD-PFA
	ORIGINAL BRAVUS	CAPRI	F-40	P-40	AD-BR
		CAPRI S.	F-40	P-40	AD-BR
		NEO-DAKKI	F-40	P-40	AD-BR
		XCODE	F-40W		AD-BR
PICARD	PIC-1E	CAPRI	F-8	P-8	
		CAPRI S.	F-8	P-8	FIC-TUB
	PIC-8D	CAPRI	F-1	P-1	
		NEO-DAKKI	F-1	P-1	
POLLUX	POL-3TEC	CAPRI	F-8	P-8	





					
POLLUX	POL-3TEC	CAPRI S.	F-8	P-8	FIC-TUB
		CAPRI	F-8	P-8	
	POL-4E	CAPRI S.	F-8	P-8	FIC-TUB
		CAPRI	F-8	P-8	
	POL-5TEC	CAPRI	F-8	P-8	
		CAPRI S.	F-8	P-8	FIC-TUB
POTENT	PTN-1D	CAPRI	F-19	P-19	
		CAPRI S.	F-19	P-19	
		NEO-DAKKI	F-19	P-19	
	PTN-2D	CAPRI	F-19	P-19	
		CAPRI S.	F-19	P-19	
		NEO-DAKKI	F-19	P-19	
PTN-3D	CAPRI	F-19	P-19		
	CAPRI S.	F-19	P-19		
	NEO-DAKKI	F-19	P-19		
PREFER	PR-21	CAPRI	F-5	P-5	
		CAPRI S.	F-5	P-5	
		NEO-DAKKI	F-5	P-5	
	PR-22	CAPRI	F-5	P-5	
CAPRI S.		F-5	P-5		
ROSSETTI	ROSE-1	CAPRI	F-1	P-1	
		CAPRI S.	F-1	P-1	
		NEO-DAKKI	F-1	P-1	
SAAB	SAA-1P1	CAPRI	F-11	P-11	
		CAPRI S.	F-11	P-11	
		NEO-DAKKI	F-11	P-11	
		XCODE	F-11W		
SEA	SEA-1	CAPRI	F-1	P-1	
		CAPRI	F-3	P-3	
		CAPRI S.	F-1	P-1	
		CAPRI S.	F-3	P-3	
	SEA-2	NEO-DAKKI	F-1	P-1	
		NEO-DAKKI	F-3	P-3	
		CAPRI	F-1	P-1	
		CAPRI	F-3	P-3	
SECUREMME	SEC-1	CAPRI	F-23	P-23	
		CAPRI S.	F-23	P-23	

						
SECUREMME	SEC-1	NEO-DAKKI	F-23	P-23		
		XCODE	F-23W			
	SEC-2	CAPRI	F-19	P-19		
		CAPRI S.	F-19	P-19		
		NEO-DAKKI	F-19	P-19		
		XCODE	F-19			
	SEC-3	CAPRI	F-19	P-19		
		CAPRI S.	F-19	P-19		
		NEO-DAKKI	F-19	P-19		
SECURITAL	SCR-1	CAPRI	F-1	P-1		
		CAPRI S.	F-1	P-1		
		NEO-DAKKI	F-1	P-1		
SERRALLER	SER-1T	CAPRI	F-8	P-8		
		CAPRI S.	F-8	P-8		
	SER-3D	CAPRI	F-1	P-1	FIC-TUB	
		CAPRI S.	F-1	P-1		
		NEO-DAKKI	F-1	P-1		
XCODE	F-1W					
SIDESE	SID-1	CAPRI	F-8	P-8		
		CAPRI S.	F-8	P-8		
	SID-2	CAPRI	F-8	P-8	FIC-TUB	
CAPRI S.	F-8	P-8				
SMART	SMR-1P	CAPRI	F-11	P-11	FIC-TUB	
		CAPRI S.	F-11	P-11		
		NEO-DAKKI	F-11	P-11		
SPIDER	SPI-1	CAPRI	F-1	P-1		
		CAPRI S.	F-1	P-1		
		NEO-DAKKI	F-1	P-1		
	SPI-1D	CAPRI S.	F-1	P-1		
		NEO-DAKKI	F-1	P-1		
		CAPRI	F-1	P-1		
XCODE	F-5W					
STS	STS-35	CAPRI	F-1	P-1		
		CAPRI S.	F-1	P-1		
		NEO-DAKKI	F-1	P-1		
		XCODE	F-1W			
	STS-36	CAPRI	F-1	P-1		
		CAPRI S.	F-1	P-1		
		NEO-DAKKI	F-1	P-1		
	STS-37	CAPRI	F-1	P-1		
		CAPRI S.	F-1	P-1		
		NEO-DAKKI	F-1	P-1		

						
STS	STS-38	CAPRI	F-1	P-1		
		CAPRI S.	F-1	P-1		
		NEO-DAKKI	F-1	P-1		
	STS-B1	CAPRI	F-1	P-1		
		CAPRI S.	F-1	P-1		
		NEO-DAKKI	F-1	P-1		
	STS-T14	CAPRI	F-5	P-5		
		CAPRI S.	F-5	P-5		
		NEO-DAKKI	F-5	P-5		
		XCODE	F-5W			
	STS-TV3	CAPRI	F-1	P-1		
		CAPRI S.	F-1	P-1		
NEO-DAKKI		F-1	P-1			
XCODE	F-1W					
STS-TV5	CAPRI	F-1	P-1			
	CAPRI S.	F-1	P-1			
	NEO-DAKKI	F-1	P-1			
	XCODE	F-1W				
STS-TV8	CAPRI	F-1	P-1			
	CAPRI S.	F-1	P-1			
	NEO-DAKKI	F-1	P-1			
XCODE	F-1W					
STS-TV9	CAPRI	F-1	P-1			
	CAPRI S.	F-1	P-1			
	NEO-DAKKI	F-1	P-1			
	XCODE	F-1W				
STS-X5	CAPRI	F-5	P-5			
	CAPRI S.	F-5	P-5	AD-ST5		
	NEO-DAKKI	F-5	P-5	AD-ST5		
	XCODE	F-5W		AD-ST5		
STS-X6	CAPRI	F-5	P-5	AD-ST5		
	CAPRI S.	F-5	P-5	AD-ST5		
	NEO-DAKKI	F-5	P-5	AD-ST5		
	XCODE	F-5W		AD-ST5		
ORIGINAL CS7 / CSP-7 / CS8	XCODE	F-5W		AD-ST5		
ORIGINAL ST15	XCODE	F-23W				
ORIGINAL ST8	XCODE	F-5W		M5		
ORIGINAL ST6	XCODE	F-23W				
SUBARU	SUB-2P	CAPRI	F-11	P-11		





LLAVES DE SEGURIDAD

DIMPLE KEYS

					
SUBARU	SUB-2P	CAPRI S.	F-11	P-11	
		NEO-DAKKI	F-11	P-11	
		XCODE	F-11W		
TARONI	TRO-1	CAPRI	F-1	P-1	
		CAPRI S.	F-1	P-1	
		NEO-DAKKI	F-1	P-1	
		XCODE	F-1W		
	TRO-1D	CAPRI	F-1	P-1	
		CAPRI S.	F-1	P-1	
NEO-DAKKI		F-1	P-1		
XCODE		F-1W			
TECON	TC-1	CAPRI	F-5	P-5	
		CAPRI S.	F-5	P-5	
		NEO-DAKKI	F-5	P-5	
		XCODE	F-5W	P-5	
	TC-3	CAPRI	F-5	P-5	
		CAPRI S.	F-5	P-5	
NEO-DAKKI		F-5	P-5		
TECSESA	TEC-2	CAPRI	F-5	P-5	
		CAPRI S.	F-5	P-5	
		NEO-DAKKI	F-5	P-5	
		XCODE	F-5W		
TESA	TE-T10	CAPRI	F-5	P-5	
		CAPRI S.	F-5	P-5	
		NEO-DAKKI	F-5	P-5	
		XCODE	F-5W		
	TE-T10D	CAPRI	F-5	P-5	
		CAPRI S.	F-5	P-5	
		NEO-DAKKI	F-5	P-5	
	TE-T11	CAPRI	F-5	P-5	
		CAPRI S.	F-5	P-5	
		NEO-DAKKI	F-5	P-5	
	TE-T12PLUS	CAPRI	F-5	P-5	
		CAPRI S.	F-5	P-5	AD-T12P
		NEO-DAKKI	F-5	P-5	AD-T12P
		XCODE	F-5W		
	TE-T60	CAPRI	F-5	P-5	AD-T12P
CAPRI S.		F-5	P-5		
NEO-DAKKI		F-5	P-5		
XCODE		F-5W			
TE-T61	CAPRI	F-5	P-5		
	CAPRI S.	F-5	P-5		
	NEO-DAKKI	F-5	P-5		

					
TESA	TE-T62	CAPRI	F-5	P-5	
		CAPRI S.	F-5	P-5	
		NEO-DAKKI	F-5	P-5	
		XCODE	F-5W		
	TE-T80	CAPRI	F-5	P-5	
		CAPRI S.	F-5	P-5	
		NEO-DAKKI	F-5	P-5	
		XCODE	F-5W		
	TE-T80EH	CAPRI	F-5	P-5	
		CAPRI S.	F-5	P-5	
		NEO-DAKKI	F-5	P-5	
		XCODE	F-5W		
TE-T80SC	CAPRI	F-5	P-5		
	CAPRI S.	F-5	P-5		
	NEO-DAKKI	F-5	P-5		
	XCODE	F-5W			
TE-T82	CAPRI	F-5	P-5		
	CAPRI S.	F-5	P-5		
	NEO-DAKKI	F-5	P-5		
	XCODE	F-5W			
TIBBE	JAU-1P	CAPRI	F-22	P-22	
		CAPRI S.	F-22	P-22	AD-FO
		NEO-DAKKI	F-22	P-22	AD-FO
	JAU-2P	CAPRI	F-22	P-22	AD-FO
		CAPRI S.	F-22	P-22	AD-FO
		NEO-DAKKI	F-22	P-22	AD-FO
TITAN	TIT-6	CAPRI	F-1	P-1	AD-FO
		CAPRI S.	F-1	P-1	
		NEO-DAKKI	F-1	P-1	
		XCODE	F-6		
	TIT-25	CAPRI	F-1	P-1	
		CAPRI S.	F-1	P-1	
NEO		F-1	P-1		
TIT-22	CAPRI	F-19	P-19		
	CAPRI S.	F-19	P-19		
	NEO	F-19	P-19		
TIT-23	CAPRI	F-19	P-19		
	CAPRI S.	F-19	P-19		
	NEO	F-19	P-19		
T-KEY	TKY-2	NEO-DAKKI	F-1	P-1	FIC-TUB
		CAPRI	F-1	P-1	
		CAPRI S.	F-1	P-1	

						
TOVER	TOV-2	CAPRI	F-1	P-1		
		CAPRI S.	F-1	P-1		
		NEO-DAKKI	F-1	P-1		
	TOV-4	CAPRI	F-1	P-1		
		CAPRI S.	F-1	P-1		
		NEO-DAKKI	F-1	P-1		
		XCODE	F-1W			
	TOV-5	CAPRI	F-1	P-1		
		CAPRI S.	F-1	P-1		
		NEO-DAKKI	F-1	P-1		
		XCODE	F-19			
	TOV-6	CAPRI	F-1	P-1		
		CAPRI S.	F-1	P-1		
		NEO-DAKKI	F-1	P-1		
		XCODE	F-6			
TOV-7	CAPRI	F-1	P-1			
	CAPRI S.	F-1	P-1			
	NEO-DAKKI	F-1	P-1			
	XCODE	F-1W				
TOV-8D	CAPRI	F-1	P-1	2016		
	CAPRI S.	F-1	P-1	2016		
	NEO-DAKKI	F-1	P-1	2016		
	XCODE	F-1W		2016		
TOYOTA	TOYO-18P	CAPRI	F-11	P-11		
		CAPRI S.	F-11	P-11		
		NEO-DAKKI	F-11	P-11		
		XCODE	F-11W			
	TOYO-30P	CAPRI	F-11	P-11		
		CAPRI S.	F-11	P-11		
		NEO-DAKKI	F-11	P-11		
		XCODE	F-11W			
	TOYO-30P1	CAPRI	F-11	P-11		
		CAPRI S.	F-11	P-11		
		NEO-DAKKI	F-11	P-11		
	TOYO-36P	CAPRI	F-11	P-11		
CAPRI S.		F-11	P-11			
NEO-DAKKI		F-11	P-11			
TOYO-41P	CAPRI	F-11	P-11			
	CAPRI S.	F-11	P-11			
	NEO	F-11	P-11			
TRELOCK	TRL-4P	CAPRI	F-11	P-11		
		CAPRI S.	F-11	P-11		
		NEO-DAKKI	F-11	P-11		

						
TRW-SIPEA	FI-16P	CAPRI	F-33	P-33		
		CAPRI S.	F-33	P-33		
		NEO-DAKKI	F-33	P-33		
		XCODE	F-11W			
	SIP-4P3	CAPRI	F-11	P-11		
		CAPRI S.	F-11	P-11		
		NEO-DAKKI	F-11	P-11		
	SIP-4P4	CAPRI	F-11	P-11		
		CAPRI S.	F-11	P-11		
		NEO-DAKKI	F-11	P-11		
XCODE		F-11W				
TSAG	SAG-1T	CAPRI S.	F-8W	P-8		
		CAPRI	F-8W	P-8		FIC-TUB
		CAPRI	F-8	P-8		
		CAPRI S.	F-8	P-8		
UCEM	UCEM-13D	CAPRI	F-13	P-13		
		CAPRI S.	F-13	P-13		
		NEO-DAKKI	F-13	P-13		
	UCEM-17D	CAPRI	F-13	P-13		
		CAPRI S.	F-13	P-13		
		NEO-DAKKI	F-13	P-13		
	UCEM-5D	CAPRI	F-14	P-14		
		CAPRI S.	F-14	P-14		
		NEO-DAKKI	F-14	P-14		
	UCEM-5I	CAPRI	F-14	P-14		
		CAPRI S.	F-14	P-14		
		NEO-DAKKI	F-14	P-14		
UCEM-8D	CAPRI	F-13	P-13			
	CAPRI S.	F-13	P-13			
	NEO-DAKKI	F-13	P-13			
UCEM-8DP	CAPRI	F-13	P-13			
	CAPRI S.	F-13	P-13			
	NEO-DAKKI	F-13	P-13			
UCEM-20D	CAPRI	F-6	P-6	2016		
	CAPRI S.	F-6	P-6	2016		
	NEO-DAKKI	F-6	P-6	2016		
	XCODE	F-6		2016		
UCEM-21	CAPRI	F-11	P-11			
	CAPRI S.	F-11	P-11			

LLAVES DE SEGURIDAD

DIMPLE KEYS

					
UCEM	UCEM-21	NEO	F-11	P-11	
		XCODE	F-19W		
UNIVERSAL	TX-2	CAPRI	F-1	P-1	
		CAPRI S.	F-1	P-1	
		NEO-DAKKI	F-1	P-1	
URBIS	URB-3D	CAPRI	F-1	P-1	
		CAPRI S.	F-1	P-1	
		NEO-DAKKI	F-1	P-1	
	URB-4D	CAPRI	F-1	P-1	
		CAPRI S.	F-1	P-1	
		NEO-DAKKI	F-1	P-1	
VACHETTE	VA-11	CAPRI	F-43	P-43	
	VA-15	CAPRI	F-21	P-21	30°
		CAPRI S.	F-21	P-21	
		NEO-DAKKI	F-21	P-21	
	VA-17P	SARATOGA	FP-11		
		TITAN	FP-11		AD-NEVA
		BERNA	FP-11		AD-NEVA
		VIENNA	FP-24		AD-NEVA
		EAUTO	FP-11		AD-NEVA
		ECCO	FP-11		AD-NEVA
		EPLUS	FP-11		AD-NEVA
	VA-25	CAPRI	F-21	P-21	AD-NEVA
		CAPRI S.	F-21	P-21	15° 19°
		NEO-DAKKI	F-21	P-21	AD-VA58
	VA-26	CAPRI	F-21	P-21	AD-VA58
		CAPRI S.	F-21	P-21	15° 19°
		NEO-DAKKI	F-21	P-21	AD-VA58
	VA-27	CAPRI	F-21	P-21	AD-VA58
		CAPRI S.	F-21	P-21	15° 19°
		NEO-DAKKI	F-21	P-21	AD-VA58
		XCODE	F-21		AD-VA58
	VA-28	CAPRI	F-21	P-21	ADV-19
		CAPRI S.	F-21	P-21	15° 19°
		NEO-DAKKI	F-21	P-21	AD-VA58
	VA-56	CAPRI	F-21	P-21	AD-VA58
		CAPRI S.	F-21	P-21	15° 19°
		NEO-DAKKI	F-21	P-21	AD-VA58
	VA-58	CAPRI	F-21	P-21	AD-VA58
		CAPRI S.	F-21	P-21	15° 19°
		NEO-DAKKI	F-21	P-21	AD-VA58
	VA-70	CAPRI	F-1	P-1	AD-VA58

						
VACHETTE	VA-70	CAPRI S.	F-1	P-1		
		NEO-DAKKI	F-1	P-1		
	VA-91	CAPRI	F-1	P-1		
		CAPRI S.	F-1	P-1		
		NEO-DAKKI	F-1	P-1		
	ORIGINAL VRX	CAPRI	F-1	P-1		
		CAPRI S.	F-1	P-1	AD-VAX	
		NEO-DAKKI	F-1	P-1	AD-VAX	
	VALEO	CIT-1P	CAPRI	F-11	P-11	AD-VAX
			CAPRI S.	F-11	P-11	
NEO-DAKKI			F-11	P-11		
XCODE			F-17W			
CIT-1C1		CAPRI	F-11	P-11	AD-VAX	
		CAPRI S.	F-11	P-11		
		NEO-DAKKI	F-11	P-11		
		XCODE	F-17W			
		PEU-1C1	CAPRI	F-11	P-11	
			CAPRI S.	F-11	P-11	
NEO-DAKKI	F-11		P-11			
PEU-2C1	CAPRI	F-11	P-11			
	CAPRI S.	F-11	P-11			
	NEO-DAKKI	F-11	P-11			
PEU-1P	CAPRI	F-11	P-11			
	CAPRI S.	F-11	P-11			
	NEO-DAKKI	F-11	P-11			
VI-14	CAPRI	F-13	P-13			
	CAPRI S.	F-13	P-13			
	NEO-DAKKI	F-13	P-13			
	XCODE	F-19				
WANJIN	WAN-1D	CAPRI	F-5	P-5		
		CAPRI S.	F-5	P-5		
		NEO-DAKKI	F-5	P-5		
WILKA	WIL-22	CAPRI	F-1	P-1		
		CAPRI S.	F-1	P-1		
		NEO-DAKKI	F-1	P-1		
		XCODE	F-1W			
	CARAT P3	CAPRI	F-1	P-1		
		CAPRI S.	F-1	P-1	CP-177	
WINKHAUS	WIN-1D	NEO-DAKKI	F-1	P-1	CP-177	
		XCODE	F-1W		CP-177	
		CAPRI	F-15	P-15	AD-X07	
		CAPRI S.	F-15	P-15		

					
WINKHAUS	WIN-1D	NEO-DAKKI	F-15	P-15	P-WIN
	WIN-1I	CAPRI	F-15	P-15	P-WIN
		CAPRI S.	F-15	P-15	
		NEO-DAKKI	F-15	P-15	P-WIN
	WIN-2D	CAPRI	F-15	P-15	P-WIN
		CAPRI S.	F-15	P-15	
		NEO-DAKKI	F-15	P-15	P-WIN
	WIN-3D	CAPRI	F-15	P-15	P-WIN
		CAPRI S.	F-15	P-15	
		NEO-DAKKI	F-15	P-15	P-WIN
	WIN-4D	CAPRI	F-15	P-15	P-WIN
		CAPRI S.	F-15	P-15	
		NEO-DAKKI	F-15	P-15	P-WIN
	ORIGINAL X-TRA	XCODE	F-13W		P-WIN
XCODE		F-13W		M8	
WT	WT-1	CAPRI	F-33	P-33	AD-X09
		CAPRI S.	F-33	P-33	
		NEO-DAKKI	F-33	P-33	
YALE	YA-23	CAPRI	F-11	P-11	
		CAPRI S.	F-11	P-11	AD-JIS
		NEO-DAKKI	F-11	P-11	AD-JIS
	YA-81	CAPRI	F-19	P-19	AD-JIS
		CAPRI S.	F-19	P-19	
		NEO-DAKKI	F-19	P-19	
		XCODE	F-19	P-19	
	YA-280D	CAPRI	F-5	P-5	
		CAPRI S.	F-5	P-5	
		NEO-DAKKI	F-5	P-5	
	YA-281D	CAPRI	F-19	P-19	14°
		CAPRI	F-3	P3	
	YA-282	CAPRI	F-5	P-5	
		CAPRI S.	F-5	P-5	
		NEO-DAKKI	F-5	P-5	
X-CODE		F-19W			
YALE (ORIG.)	YA-306 (ORIG.)	CAPRI	F-5	P-5	
		F-5	P-5		
		NEO	F-5	P-5	
		XCODE	F-5W		
YARDENI	YAR-1	CAPRI	F-13	P-13	
		CAPRI S.	F-13	P-13	
		NEO-DAKKI	F-13	P-13	
		XCODE	F-13W		

					
YARDENI	YAR-2	CAPRI	F-13	P-13	
		CAPRI S.	F-13	P-13	
		NEO-DAKKI	F-13	P-13	
		XCODE	F-13W		
	YAR-3	CAPRI	F-13	P-13	
		CAPRI S.	F-13	P-13	
		NEO-DAKKI	F-13	P-13	
		XCODE	F-13W		
	YAR-4D	CAPRI	F-13	P-13	
		CAPRI S.	F-13	P-13	
NEO-DAKKI		F-13	P-13		
ZADI	ZA-10	CAPRI	F-1	P-1	
		CAPRI S.	F-1	P-1	
		NEO-DAKKI	F-1	P-1	
		XCODE	F-5W		
ZA-14P	CAPRI	F-33	P-33		
	CAPRI S.	F-33	P-33		
	NEO-DAKKI	F-33	P-33		
	XCODE	F-22			

LLAVES ORIGINALES

JATORRIZKO GILTZAK

ORIGINAL KEYS

CLES ORIGINALES

ORIGINALSCHLÜSSEL



LLAVES DE SEGURIDAD

SEGURITATEZKO GILTZAK

DIMPLE KEYS



CLES DE SECURITE

BOHRMULDENSCHLÜSSEL

THE KEY TO EXCELLENCE

GLOBALLY UNLOCKING MILLIONS OF DOORS DAILY

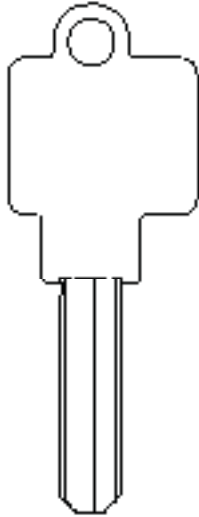
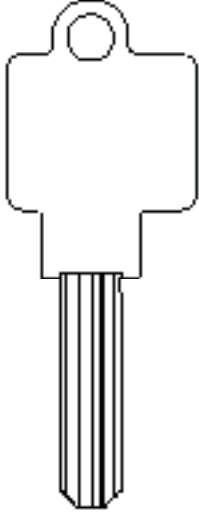
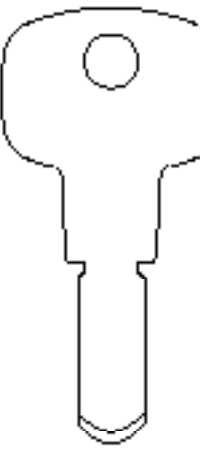
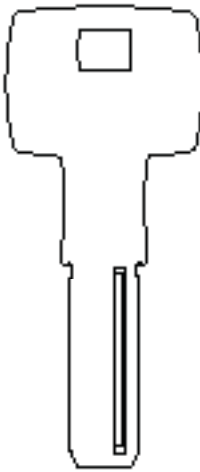
**LLAVES DE
SEGURIDAD**
SECURITY KEYS

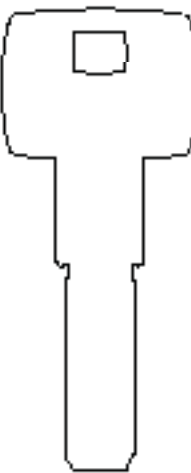
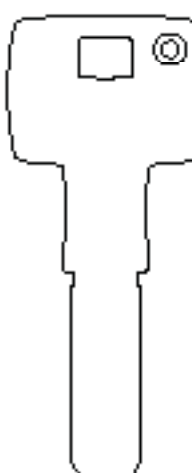
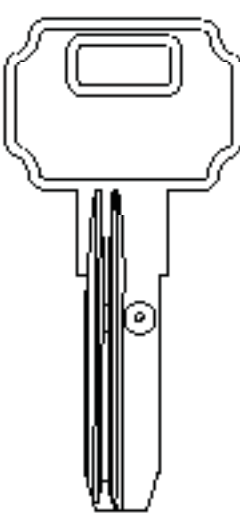
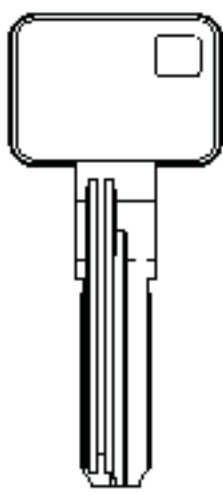
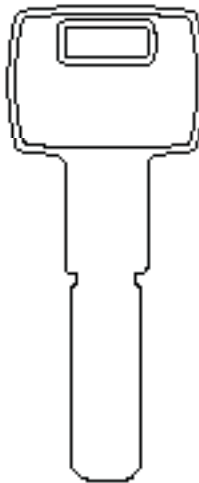
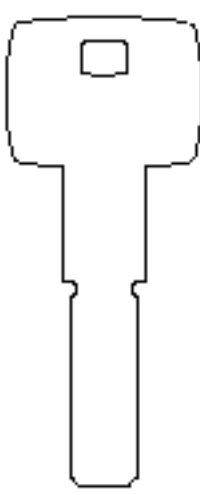
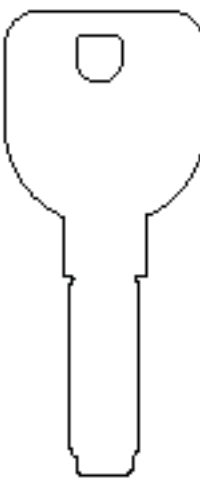
BKS		CES	DOM
 <p>WPSH MW</p>	 <p>WPSH RA RK RZ</p>	 <p>WPSH</p>	 <p>DK DAS</p>
DOM			LINCE
 <p>DK DAS</p>	 <p>DK NS</p>	 <p>DK SR</p>	 <p>DK CD</p>
LINCE		STS	VACHETTE
 <p>DK</p>	 <p>DK</p>	 <p>DK STS</p>	 <p>WPSH ORIGINAL</p>

WINKHAUS

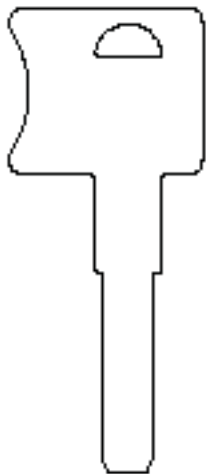

X-TRA ORIGINAL

LLAVES DE
SEGURIDAD
SECURITY KEYS

JMA[®]



ATENCIÓN: Concerniente a las marcas y denominaciones comerciales ver nota en índice.
ATTENTION: Concerning the marks and commercial denominations see note in index.
ATTENTION: Concernant les marques et dénominations commerciales voir la note dans l'index.
ACHTUNG: Beziehen auf die Marke und Handelsname sehen Sie die Notiz im Index.

MÁQUINAS DUPLICADORAS

*MAKINA MEKANIKOAK
KEY CUTTING MACHINES
MACHINES A REPRODUIRE
SCHLÜSSELKOPIERMASCHINEN*



PARA LLAVES PLANAS

*GILTZA LAUETARAKO
FOR CYLINDER KEYS
POUR CLES PLATES
FÜR ZYLINDERSCHLÜSSEL*

THE KEY TO EXCELLENCE
GLOBALLY UNLOCKING MILLIONS OF DOORS DAILY

VIENNA



La VIENNA es la máquina duplicadora de JMA para llaves planas para cilindro, vehículo y llaves cruciformes, diseñada para los profesionales de la duplicación. Nos trae un sistema innovador electrónico que hace que el ajuste de la máquina sea sencillo también para aquellas personas iniciadas en el duplicado, siguiendo unos pasos muy sencillos de ajuste, garantiza óptimos resultados de duplicado.

The VIENNA is the JMA cylinder key duplicating machine for cylinder locks, vehicle and cruciform keys, designed for key duplicating professionals. The Vienna has an innovative electronic system for easy adjustment of the machine as well as for those with long experience in duplicating, with a few simple steps for adjustment to guarantee optimal duplication results.

VIENNA SMART



La VIENNA SMART es la máquina duplicadora de JMA para llaves planas para cilindro, vehículo y llaves cruciformes, diseñada para los profesionales de la duplicación. Se combinan sencillez y versatilidad a la hora de duplicar llaves planas para cerraduras a cilindro y para vehículos, llaves cruciformes (en cruz) y especiales, gracias a su mordaza de 4 lados.

The VIENNA SMART is the JMA cylinder key duplicating machine for cylinder locks, vehicle and cruciform keys, designed for key duplicating professionals. Combining simplicity and versatility in the duplication of flat keys for cylinder locks and for vehicles, cruciform keys (cross-shaped) and special keys, thanks to its 4-sided clamp.

VIENNA XCLUSIVE



La VIENNA XCLUSIVE es la máquina duplicadora de JMA para llaves planas para cilindro, vehículo y llaves cruciformes, diseñada para los profesionales de la duplicación. Se trata de la Vienna personalizada con un palpador inclinable para la reproducción de las llaves BRI-10, BRI-11, BRI-12 y mordaza de acero 4 caras amarre M-V-BD especial BRICARD.

VIENNA XCLUSIVE is the cylinder key duplicating machine for cylinder locks, vehicle and cruciform keys, designed for key duplicating professionals. Fitted with tiltable tracer for duplicating BRI-10, BRI-11, BRI-12 and steel 4-sided jaw M-V-BD special BRICARD.

BERNA



BERNA es la máquina duplicadora compacta profesional en el que se combinan sencillez y versatilidad. Las tecnologías y materiales de última generación hacen de ella una máquina duplicadora resistente y precisa en el duplicado.

BERNA is the compact professional model of duplicating machine that combines simplicity and versatility. The latest generation techniques and materials make it a resistant and precise duplicating machine.

SARATOGA



Máquina duplicadora mixta de llaves planas, cruciformes, y por otro lado gorja de un paletón y doble paletón, frontales y especiales, pudiendo duplicar otros modelos de llaves con sus carros opcionales como regata, FORD®, ABLOY®. La Saratoga es una máquina robusta, sólida y fiable. Estas características y su versatilidad, hacen de ella una máquina indispensable en cualquier punto de duplicado.

Mixed duplicating machine for flat keys, cruciform keys, and also for single and double bit keys, frontal and special keys, being able to duplicate other models of keys with its optional carriages like channel, FORD® and ABLOY® keys. The Saratoga is a strong, solid and reliable machine. These characteristics and its versatility have made it a necessary machine for any duplicating point.

AVANTCODE



Avantcode es la máquina electrónica de nueva generación más avanzada JMA para duplicar llaves de cilindro y vehículos, que permite el dentado de llaves de un lado y doble lado de mecanizado. Su velocidad y robustez garantiza la calidad óptima de corte al duplicar las llaves.

Avantcode is JMA's most advanced new generation electronic machine for duplicating cylinder and car keys that allows the biting of keys with single or double sided machining. Its speed and strength guarantee the optimal quality of the cut when duplicating keys.

LLAVES PLANAS

CYLINDER KEYS

ECCO



Máquina semiautomática para el duplicado de llaves planas para cerraduras de cilindro y para vehículos, llaves cruciformes (en cruz) y especiales. LA ECCO es la expresión más sencilla de una máquina duplicadora sin perder la precisión en el duplicado. Su fresa con eje directo al motor hacen de ella la versión más económica en la familia de duplicadoras de llaves planas.

Semiautomatic machine for duplicating flat keys for cylinder locks and for vehicles, cruciform keys (cross-shaped) and special keys. The ECCO is the simplest expression of a duplicating machine without losing precision in the duplication. Its cutter directly fitted to the motor axle makes it the most economic model of the flat key duplicator machine family.

ECCO AUTO



Máquina semiautomática para el duplicado de llaves planas para cerraduras de cilindro y para vehículos, llaves cruciformes (en cruz) y especiales. LA ECCO AUTOMATIC es la expresión más sencilla de una máquina duplicadora sin perder la precisión en el duplicado. Su fresa con eje directo al motor hacen de ella la versión más económica en la familia de duplicadoras de llaves planas.

Semiautomatic machine for duplicating flat keys for cylinder locks and for vehicles, cruciform keys (cross-shaped) and special keys. THE ECCO AUTOMATIC is the simplest expression of a duplicating machine without losing precision in the duplication. Its cutter directly fitted to the motor axle makes it the most economic model of the flat key duplicator machine family.

ECCO PLUS



Máquina semiautomática para el duplicado de llaves planas para cerraduras de cilindro y para vehículos, llaves cruciformes (en cruz) y especiales. LA ECCO PLUS es la expresión más sencilla de una máquina duplicadora sin perder la precisión en el duplicado. Su fresa con eje directo al motor hacen de ella la versión más económica en la familia de duplicadoras de llaves planas.

Semiautomatic machine for duplicating flat keys for cylinder locks and for vehicles, cruciform keys (cross-shaped) and special keys. The ECCO PLUS is the simplest expression of a duplicating machine without losing precision in the duplication. Its cutter directly fitted to the motor axle makes it the most economic model of the flat key duplicator machine family.

MULTICODE



MULTICODE le ofrece la solución profesional 'todo en uno' para su negocio. Su multifuncionalidad le permite copiar llaves planas, de seguridad y de automoción sin cambiar de máquina. Conozca su potencia y rapidez para mecanizar llaves de una sola pasada y descubra su última tecnología, que incorpora una tableta y la APP JMAKEYPRO para facilitar el duplicado de todo el catálogo JMA y sus equivalencias.

MULTICODE offers an all-in-one professional solution for your business. Its multi-functional nature means it can cut to code and copy cylinder, dimple and vehicle keys without needing to switch machines. Witness its power and speed for cutting keys in a single motion and discover its cutting-edge technology, which uses a tablet and the JMAKEYPRO app for duplicating the entire catalogue of JMA keys and their equivalents.

NOTA: La máquina Multicode tiene su propio catálogo especialista. Para consultar dicha información visite el siguiente enlace:

NOTE: The Multicode machine has its own specialist catalog. To check this information, visit the following link:





FRESAS MILLING CUTTERS

CODE	AXBXC	D	E	PALP.	PARA-FOR	MAT
FP-1	25x10x10	50	0		OREGON	HSS
FP-2W	40x6x10	35	0,1		VIRGINIA	W
FP-3	50x6x12	45	0,15		KIS	HSS
FP-4	53x6,3x12	45	0,1		KIS	HSS
FP-5	57x5x12,7	45	0,15		JMA	HSS
FP-6	60x5x12,7	42	0,1		SPRINT	HSS
FP-11	63x5x16	42	0,15		ECCO-ECCO PLUS-ECCO AUTO-MATIC	HSS
FP-12	63x5x16	40	0,1		TUCSON	HSS
FP-13	63x5x16-150D	42	0,1		DALLAS	HSS
FP-14	70x13x7	45	0		LINCE CE-2	HSS
FP-15	70x13x7-110	55	0		LINCE CM-1	HSS
FP-16	70x5,25x16	40	0,1		PROCEDURE	HSS
FP-16W	70x5,25x16	40	0,1		PROCEDURE-AVANTCODE	W
FP-24	80x5x16	42	0,15		BERNA- VIENNA-VIENNA S. DAKOTA EXTRA-SARATOGA-NEVADA-DENVER-TITAN-TITAN MASTER-	HSS
FP-25	80x5x16,30	42,3	0,15		LINCE CA-3	HSS
FP-32	63x2,4x16	45	0,5		ECCO-ECCO PLUS MEXICO - LATÓN	HSS
FP-41	80x8x16	50	1,2	P-81	C.CLAMP FB-489 SPECIAL	HSS
FP-42	80x8x16	45	0,85	P-82	C.CLAMP RU-488 SPECIAL	HSS
FP-43	80x8x16	45	1,55	P-83	C.CLAMP TE-476 SPECIAL	HSS
FP-44	80x8x16	52,5	0,15	P-84	C.CLAMP AB-744 SPECIAL	HSS
FP-46	80x8x16	45		P-86	C.CLAMP BA-570 SPECIAL	HSS
FP-49	80x8x16	45	0,4	P-89	C.CLAMP UNIVERSAL 90°	HSS
FP-50	80x8x16	50	0,4	P-90	C.CLAMP UNIVERSAL 100°	HSS

CEPILLOS / BRUSHES

CODE	F	PARA-FOR
C1	60x10	BOSTON
C2	75x10	CE-2
C3	80x13	DAKOTA-DAKOTA-EXTRA
C4	80x10	DAKOTA ANTIGUA-NEVADA-KANSAS-DENVER
C5	100x13	SARATOGA-YAKARTA
C6	65x13	ECCO-PLUS, ECCO-BIT
C7	75x13 (Nylon)	PROCEDURE - SENNA - VIENNA

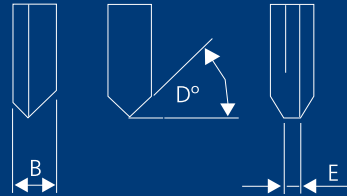
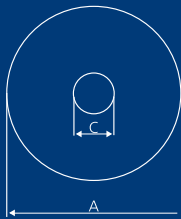

SIMBOLOGÍA / SYMBOLS

W

Fresa de metal duro
Metal gogorreko fresa
Hard metal cutters
Fraise en métal dur
Hartmetallfräse

HSS

Acero extra rápido
Altzairu estra azkarra
High-speed steel
Acier extra rapide
Extraschneller Stahl



Espesor
Lodiera
Thickness
Épaisseur
Stärke



Diámetro interior
Barnealdeko diametroa
Internal diameter
Alésage
Innen-Durchmesser



Ángulo de corte
Ebaketa-angelua
Cutting angle
Angle de coupe
Schnittwinkel



Parte llana ángulo de corte
Ebaketa-angeluko alde laua
Flat part cutting angle
Partie plate angle de coupe
Flacher Teil, Schnittwinkel



Diámetro externo
Kanpoaldeko diametroa
External diameter
Diamètre extérieur
Aussen-Durchmesser



FRESAS / MILLING CUTTERS

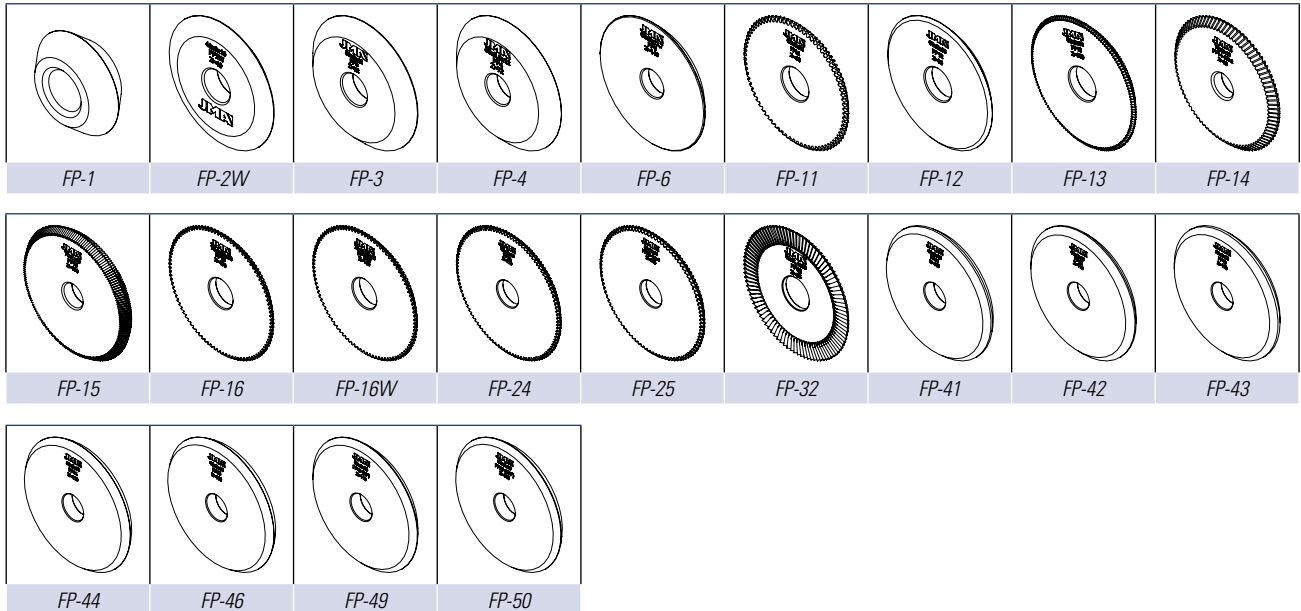

PALPADORES / TRACERS

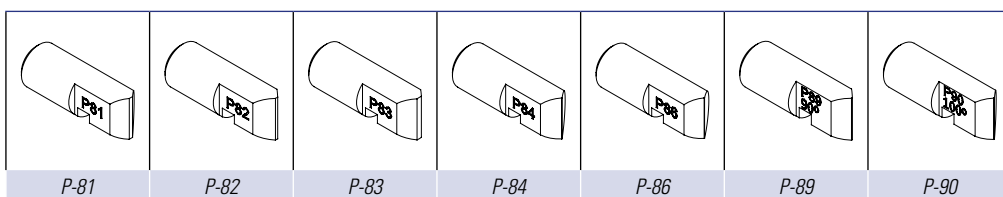

CEPILLOS / BRUSHES

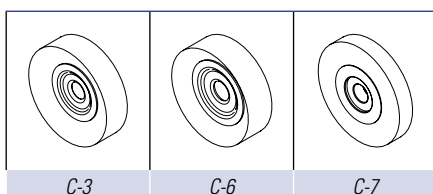



ADAPTADORES / ADAPTERS

AD-ALA-1X	AD-BLU-1X	AD-BRI-3X	AD-BUR-5X	AD-D12	AD-PO
AD-SIX	AD-SP	AV1	AV2	AV3	C.CLAMP AB-744
C.CLAMP AZ-507	C.CLAMP BA-570	C.CLAMP DO-716	C.CLAMP FB-489	C.CLAMP MCM-506	C.CLAMP RU-488

ADAPTADOR	VIENNA	VIENNA SMART	BERNA	ECCO	ECCO PLUS	ECCO AUTO	SARATOGA	AVANTCODE	PROCEDURE
AD-ALA-1X	X	X	X	X	X		X		
AD-BLU-1X	X	X	X	X	X		X		
AD-BRI-3X	X	X	X	X	X		X		
AD-BUR-5X	X	X	X	X	X		X		
AD-D12	X	X	X	X	X	X	X	X	X
AD-PO	X	X	X	X	X		X		
AD-SIX	X	X	X	X	X		X	X	
AD-SP	X	X	X	X	X	X	X	X	X
AV1								X	
AV2								X	
AV3								X	
C.CLAMP AB-744		X	X				X		
C.CLAMP AZ-507		X	X				X		

LLAVES PLANAS

CYLINDER KEYS

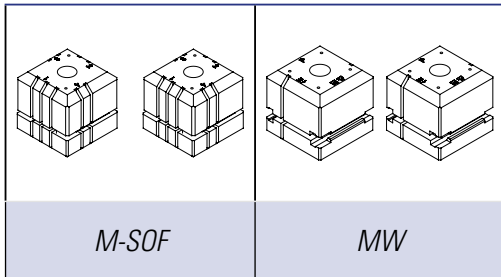
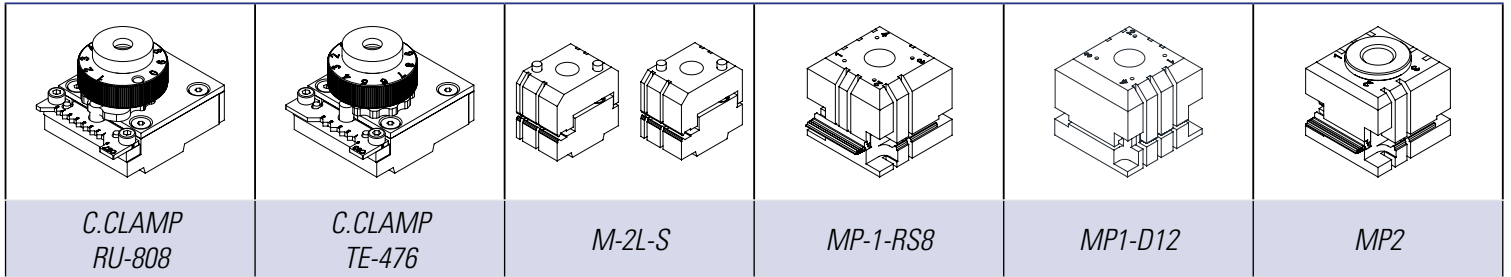

ADAPTADOR	VIENNA	VIENNA SMART	BERNA	ECCO	ECCO PLUS	ECCO AUTO	SARATOGA	AVANTCODE	PROCEDURE
<i>C.CLAMP BA-570</i>		X	X				X		
<i>C.CLAMP DO-716</i>		X	X				X		
<i>C.CLAMP FB-489</i>		X	X				X		
<i>C.CLAMP MCM-506</i>		X	X				X		
<i>C.CLAMP RU-808</i>		X	X				X		
<i>C.CLAMP RU-488</i>		X	X				X		
<i>C.CLAMP TE-476</i>		X	X				X		
<i>M-2L-S</i>				X	X				
<i>MP-1-RS8</i>								X	
<i>MP1-D12</i>								X	
<i>MP2</i>									X
<i>M-SOF</i>	X	X	X				X		
<i>MW</i>	X	X	X			X	X		

FICHA ESPECIALISTA

ESPEZIALISTAREN FITXA

SPECIALIST FILE

FICHE SPÉCIALISÉE

DATENBLATT FÜR FACHLEUTE



PARA LLAVES PLANAS

GILTZA LAUETARAKO





FOR CYLINDER KEYS







POUR CLES PLATES

FÜR ZYLINDERSCHLÜSSEL

THE KEY TO EXCELLENCE







GLOBALLY UNLOCKING MILLIONS OF DOORS DAILY







						
ABLOY	ABL-1	AVANTCODE	FP-27W			AV2
	ABL-2	AVANTCODE	FP-27W			AV2
	ABL-3	AVANTCODE	FP-27W			AV2
	ABL-3D	AVANTCODE	FP-27W			AV2
	ABL-4	AVANTCODE	FP-27W			AV2
	ABL-7	AVANTCODE	FP-27W			AV2
ABUS	ABU-29P	AVANTCODE	FP-27W			AV3
	ORIGINAL XP/SP	SARATOGA	FP-44	P-84		C.CLAMP AB-744
		VIENNA	FP-44	P-84		C.CLAMP AB-744
		VIENNA S.	FP-44	P-84		C.CLAMP AB-744
		BERNA	FP-44	P-84		C.CLAMP AB-744
	SARATOGA					AD-SP
	VIENNA					AD-SP
	VIENNA S.					AD-SP
	BERNA					AD-SP
AVANTCODE					AD-SP	
ALA	ALA-1X	SARATOGA				AD-ALA-1X
		VIENNA				AD-ALA-1X
		VIENNA S.				AD-ALA-1X
		BERNA				AD-ALA-1X
		ECCO				AD-ALA-1X
		EPLUS				AD-ALA-1X
		EAUTO				AD-ALA-1X
ASSA / RUKO / TRIO-VING	ORIGINAL D12	SARATOGA				AD-D12
		VIENNA				AD-D12
		VIENNA S.				AD-D12
		BERNA				AD-D12
		ECCO				AD-D12
		EPLUS				AD-D12
		EAUTO				AD-D12
		AVANTCODE				MP1-D12
AZBE	AZ-1D	SARATOGA	FP-49	P-89		C.CLAMP AZ-507
		VIENNA	FP-49	P-89		C.CLAMP AZ-507
		VIENNA S.	FP-49	P-89		C.CLAMP AZ-507
		BERNA	FP-49	P-89		C.CLAMP AZ-507
	AZ-11	SARATOGA	FP-49	P-89		C.CLAMP AZ-507

							
AZBE	AZ-11	VIENNA	FP-49	P-89		C.CLAMP AZ-507	
		VIENNA S.	FP-49	P-89		C.CLAMP AZ-507	
		BERNA	FP-49	P-89		C.CLAMP AZ-507	
	AZ-17D	SARATOGA	FP-49	P-89		C.CLAMP AZ-507	
	VIENNA	FP-49	P-89		C.CLAMP AZ-507		
	VIENNA S.	FP-49	P-89		C.CLAMP AZ-507		
BASI	BA-1D	SARATOGA	FP-46	P-86		C.CLAMP BA-570	
		VIENNA	FP-46	P-86		C.CLAMP BA-570	
		VIENNA S.	FP-46	P-86		C.CLAMP BA-570	
		BERNA	FP-46	P-86		C.CLAMP BA-570	
BLUMA	BLU-1X	SARATOGA				AD-BLU-1X	
		VIENNA				AD-BLU-1X	
		VIENNA S.				AD-BLU-1X	
		BERNA				AD-BLU-1X	
		ECCO				AD-BLU-1X	
		EPLUS				AD-BLU-1X	
BRICARD	BRI-10	VIENNA EX.					
	BRI-12	VIENNA EX.					
	BRI-3X	SARATOGA					AD-BRI-3X
		VIENNA					AD-BRI-3X
		VIENNA EX.					
		VIENNA S.					AD-BRI-3X
		BERNA					AD-BRI-3X
		ECCO					AD-BRI-3X
EPLUS					AD-BRI-3X		
EAUTO					AD-BRI-3X		
BURG	BUR-4X	SARATOGA				AD-BLU-1X	
		VIENNA				AD-BLU-1X	
		VIENNA S.				AD-BLU-1X	
		BERNA				AD-BLU-1X	
		ECCO				AD-BLU-1X	
		EPLUS				AD-BLU-1X	
	EAUTO				AD-BLU-1X		
BUR-5X	SARATOGA					AD-BUR-5X	







LLAVES PLANAS

CYLINDER KEYS

					
BURG	<i>BUR-5X</i>	<i>VIENNA</i>			<i>AD-BUR-5X</i>
		<i>VIENNA S.</i>			<i>AD-BUR-5X</i>
		<i>BERNA</i>			<i>AD-BUR-5X</i>
		<i>ECCO</i>			<i>AD-BUR-5X</i>
		<i>EPLUS</i>			<i>AD-BUR-5X</i>
		<i>EAUTO</i>			<i>AD-BUR-5X</i>
DOM	<i>ORIGINAL RS8</i>	<i>SARATOGA</i>	<i>FP-49</i>	<i>P-89</i>	<i>C.CLAMP DO-716</i>
		<i>VIENNA</i>	<i>FP-49</i>	<i>P-89</i>	<i>C.CLAMP DO-716</i>
		<i>VIENNA S.</i>	<i>FP-49</i>	<i>P-89</i>	<i>C.CLAMP DO-716</i>
		<i>BERNA</i>	<i>FP-49</i>	<i>P-89</i>	<i>C.CLAMP DO-716</i>
		<i>AVANTCODE</i>			<i>MP-1-RS8</i>
		<i>PROCEDURE</i>			<i>MP2</i>
FAB	<i>F-B-2D</i>	<i>SARATOGA</i>	<i>FP-50</i>	<i>P-90</i>	<i>C.CLAMP FB-489</i>
		<i>VIENNA</i>	<i>FP-50</i>	<i>P-90</i>	<i>C.CLAMP FB-489</i>
		<i>VIENNA S.</i>	<i>FP-50</i>	<i>P-90</i>	<i>C.CLAMP FB-489</i>
		<i>BERNA</i>	<i>FP-50</i>	<i>P-90</i>	<i>C.CLAMP FB-489</i>
	<i>F-B-2I</i>	<i>SARATOGA</i>	<i>FP-50</i>	<i>P-90</i>	<i>C.CLAMP FB-489</i>
		<i>VIENNA</i>	<i>FP-50</i>	<i>P-90</i>	<i>C.CLAMP FB-489</i>
		<i>VIENNA S.</i>	<i>FP-50</i>	<i>P-90</i>	<i>C.CLAMP FB-489</i>
		<i>BERNA</i>	<i>FP-50</i>	<i>P-90</i>	<i>C.CLAMP FB-489</i>
	<i>F-B-4</i>	<i>SARATOGA</i>	<i>FP-50</i>	<i>P-90</i>	<i>C.CLAMP FB-489</i>
		<i>VIENNA</i>	<i>FP-50</i>	<i>P-90</i>	<i>C.CLAMP FB-489</i>
		<i>VIENNA S.</i>	<i>FP-50</i>	<i>P-90</i>	<i>C.CLAMP FB-489</i>
		<i>BERNA</i>	<i>FP-50</i>	<i>P-90</i>	<i>C.CLAMP FB-489</i>
	<i>F-B-5</i>	<i>SARATOGA</i>	<i>FP-50</i>	<i>P-90</i>	<i>C.CLAMP FB-489</i>
		<i>VIENNA</i>	<i>FP-50</i>	<i>P-90</i>	<i>C.CLAMP FB-489</i>
		<i>VIENNA S.</i>	<i>FP-50</i>	<i>P-90</i>	<i>C.CLAMP FB-489</i>
		<i>BERNA</i>	<i>FP-50</i>	<i>P-90</i>	<i>C.CLAMP FB-489</i>
	<i>F-B-6</i>	<i>SARATOGA</i>	<i>FP-50</i>	<i>P-90</i>	<i>C.CLAMP FB-489</i>
		<i>VIENNA</i>	<i>FP-50</i>	<i>P-90</i>	<i>C.CLAMP FB-489</i>







					
FAB	<i>F-B-6</i>	<i>VIENNA S.</i>	<i>FP-50</i>	<i>P-90</i>	<i>C.CLAMP FB-489</i>
		<i>BERNA</i>	<i>FP-50</i>	<i>P-90</i>	<i>C.CLAMP FB-489</i>
	<i>F-B-7</i>	<i>SARATOGA</i>	<i>FP-50</i>	<i>P-90</i>	<i>C.CLAMP FB-489</i>
		<i>VIENNA</i>	<i>FP-50</i>	<i>P-90</i>	<i>C.CLAMP FB-489</i>
		<i>VIENNA S.</i>	<i>FP-50</i>	<i>P-90</i>	<i>C.CLAMP FB-489</i>
	<i>F-B-8</i>	<i>BERNA</i>	<i>FP-50</i>	<i>P-90</i>	<i>C.CLAMP FB-489</i>
		<i>SARATOGA</i>	<i>FP-50</i>	<i>P-90</i>	<i>C.CLAMP FB-489</i>
		<i>VIENNA</i>	<i>FP-50</i>	<i>P-90</i>	<i>C.CLAMP FB-489</i>
	<i>F-B-9</i>	<i>VIENNA S.</i>	<i>FP-50</i>	<i>P-90</i>	<i>C.CLAMP FB-489</i>
		<i>BERNA</i>	<i>FP-50</i>	<i>P-90</i>	<i>C.CLAMP FB-489</i>
		<i>SARATOGA</i>	<i>FP-50</i>	<i>P-90</i>	<i>C.CLAMP FB-489</i>
	<i>F-B-10</i>	<i>VIENNA</i>	<i>FP-50</i>	<i>P-90</i>	<i>C.CLAMP FB-489</i>
<i>VIENNA S.</i>		<i>FP-50</i>	<i>P-90</i>	<i>C.CLAMP FB-489</i>	
<i>BERNA</i>		<i>FP-50</i>	<i>P-90</i>	<i>C.CLAMP FB-489</i>	
<i>F-B-11</i>	<i>SARATOGA</i>	<i>FP-50</i>	<i>P-90</i>	<i>C.CLAMP FB-489</i>	
	<i>VIENNA</i>	<i>FP-50</i>	<i>P-90</i>	<i>C.CLAMP FB-489</i>	
	<i>VIENNA S.</i>	<i>FP-50</i>	<i>P-90</i>	<i>C.CLAMP FB-489</i>	
<i>F-B-12</i>	<i>BERNA</i>	<i>FP-50</i>	<i>P-90</i>	<i>C.CLAMP FB-489</i>	
	<i>SARATOGA</i>	<i>FP-50</i>	<i>P-90</i>	<i>C.CLAMP FB-489</i>	
	<i>VIENNA</i>	<i>FP-50</i>	<i>P-90</i>	<i>C.CLAMP FB-489</i>	
<i>F-B-13</i>	<i>VIENNA S.</i>	<i>FP-50</i>	<i>P-90</i>	<i>C.CLAMP FB-489</i>	
	<i>BERNA</i>	<i>FP-50</i>	<i>P-90</i>	<i>C.CLAMP FB-489</i>	



						
FAB	F-B-13	VIENNA	FP-50	P-90	C.CLAMP FB-489	
		VIENNA S.	FP-50	P-90	C.CLAMP FB-489	
		BERNA	FP-50	P-90	C.CLAMP FB-489	
	F-B-14	SARATOGA	FP-50	P-90	C.CLAMP FB-489	
		VIENNA	FP-50	P-90	C.CLAMP FB-489	
		VIENNA S.	FP-50	P-90	C.CLAMP FB-489	
		BERNA	FP-50	P-90	C.CLAMP FB-489	
	F-B-15	SARATOGA	FP-50	P-90	C.CLAMP FB-489	
		VIENNA	FP-50	P-90	C.CLAMP FB-489	
		VIENNA S.	FP-50	P-90	C.CLAMP FB-489	
		BERNA	FP-50	P-90	C.CLAMP FB-489	
	F-B-16	SARATOGA	FP-50	P-90	C.CLAMP FB-489	
		VIENNA	FP-50	P-90	C.CLAMP FB-489	
		VIENNA S.	FP-50	P-90	C.CLAMP FB-489	
		BERNA	FP-50	P-90	C.CLAMP FB-489	
	F-B-17	SARATOGA	FP-50	P-90	C.CLAMP FB-489	
		VIENNA	FP-50	P-90	C.CLAMP FB-489	
		VIENNA S.	FP-50	P-90	C.CLAMP FB-489	
		BERNA	FP-50	P-90	C.CLAMP FB-489	
	F-B-18	SARATOGA	FP-50	P-90	C.CLAMP FB-489	
VIENNA		FP-50	P-90	C.CLAMP FB-489		
VIENNA S.		FP-50	P-90	C.CLAMP FB-489		
F-B-18	BERNA	FP-50	P-90	C.CLAMP FB-489		
F-B-26	SARATOGA	FP-50	P-90	C.CLAMP FB-489		
	VIENNA	FP-50	P-90	C.CLAMP FB-489		
	VIENNA S.	FP-50	P-90	C.CLAMP FB-489		
	BERNA	FP-50	P-90	C.CLAMP FB-489		

						
FAB	F-B-27	SARATOGA	FP-50	P-90	C.CLAMP FB-489	
		VIENNA	FP-50	P-90	C.CLAMP FB-489	
		VIENNA S.	FP-50	P-90	C.CLAMP FB-489	
		BERNA	FP-50	P-90	C.CLAMP FB-489	
	F-B-28	SARATOGA	FP-50	P-90	C.CLAMP FB-489	
		VIENNA	FP-50	P-90	C.CLAMP FB-489	
		VIENNA S.	FP-50	P-90	C.CLAMP FB-489	
		BERNA	FP-50	P-90	C.CLAMP FB-489	
	F-B-29	SARATOGA	FP-50	P-90	C.CLAMP FB-489	
		VIENNA	FP-50	P-90	C.CLAMP FB-489	
		VIENNA S.	FP-50	P-90	C.CLAMP FB-489	
		BERNA	FP-50	P-90	C.CLAMP FB-489	
F-B-30	SARATOGA	FP-50	P-90	C.CLAMP FB-489		
	VIENNA	FP-50	P-90	C.CLAMP FB-489		
	VIENNA S.	FP-50	P-90	C.CLAMP FB-489		
	BERNA	FP-50	P-90	C.CLAMP FB-489		
F-B-32	SARATOGA	FP-50	P-90	C.CLAMP FB-489		
	VIENNA	FP-50	P-90	C.CLAMP FB-489		
	VIENNA S.	FP-50	P-90	C.CLAMP FB-489		
	BERNA	FP-50	P-90	C.CLAMP FB-489		
FIAM	FM-1X	SARATOGA			AD-ALA-1X	
		VIENNA			AD-ALA-1X	
		VIENNA S.			AD-ALA-1X	
		BERNA			AD-ALA-1X	
		ECCO			AD-ALA-1X	
		EPLUS			AD-ALA-1X	
	EAUTO			AD-ALA-1X		
FORD	FO-6P	AVANTCODE	FP-27W		AV1	
GE GE	GE-2 Pextra Flex	SARATOGA	FP-49	P-89	C.CLAMP RU-808	
		VIENNA	FP-49	P-89	C.CLAMP RU-808	







LLAVES PLANAS

CYLINDER KEYS

					
GE GE	<i>GE-2 Pextra Flex</i>	VIENNA S.	FP-49	P-89	C.CLAMP RU-808
		BERNA	FP-49	P-89	C.CLAMP RU-808
HUF	<i>PO-1P</i>	SARATOGA			AD-PO
		VIENNA			AD-PO
		VIENNA S.			AD-PO
		BERNA			AD-PO
		ECCO			AD-PO
		EPLUS			AD-PO
		EAUTO			AD-PO
	<i>PO-2P</i>	SARATOGA			AD-PO
		VIENNA			AD-PO
		VIENNA S.			AD-PO
		BERNA			AD-PO
		ECCO			AD-PO
		EPLUS			AD-PO
		EAUTO			AD-PO
MCM	<i>MCM-13D</i>	SARATOGA	FP-49	P-89	C.CLAMP MCM-506
		VIENNA	FP-49	P-89	C.CLAMP MCM-506
		VIENNA S.	FP-49	P-89	C.CLAMP MCM-506
		BERNA	FP-49	P-89	C.CLAMP MCM-506
	<i>MCM-18D</i>	SARATOGA	FP-49	P-89	C.CLAMP MCM-506
		VIENNA	FP-49	P-89	C.CLAMP MCM-506
		VIENNA S.	FP-49	P-89	C.CLAMP MCM-506
		BERNA	FP-49	P-89	C.CLAMP MCM-506
	<i>MCM-30</i>	SARATOGA	FP-49	P-89	C.CLAMP MCM-506
		VIENNA	FP-49	P-89	C.CLAMP MCM-506
		VIENNA S.	FP-49	P-89	C.CLAMP MCM-506
		BERNA	FP-49	P-89	C.CLAMP MCM-506
MIWA	<i>MIW-2</i>	SARATOGA			MW
		VIENNA			MW
		VIENNA S.			MW
		BERNA			MW
		ECCO			MW
		EPLUS			MW

					
MIWA	<i>MIW-2</i>	EAUTO			MW
		MIW-3	SARATOGA		
		VIENNA			MW
		VIENNA S.			MW
		BERNA			MW
		ECCO			MW
		EPLUS			MW
		EAUTO			MW
	<i>MIW-4</i>	SARATOGA			MW
		VIENNA			MW
		VIENNA S.			MW
		BERNA			MW
		ECCO			MW
		EPLUS			MW
EAUTO				MW	
MSV	<i>MSV-1</i>	SARATOGA			M-SOF
		VIENNA			M-SOF
		VIENNA S.			M-SOF
		BERNA			M-SOF
		ECCO			M-SOF
		EPLUS			M-SOF
	<i>MSV-2</i>	SARATOGA			M-SOF
		VIENNA			M-SOF
		VIENNA S.			M-SOF
		BERNA			M-SOF
		ECCO			M-SOF
		EPLUS			M-SOF
		EAUTO			M-SOF
		RUKO	<i>RU-11D</i>	SARATOGA	FP-49
VIENNA	FP-49			P-89	C.CLAMP RU-488
VIENNA S.	FP-49			P-89	C.CLAMP RU-488
BERNA	FP-49			P-89	C.CLAMP RU-488
<i>RU-12D</i>	SARATOGA		FP-49	P-89	C.CLAMP RU-488
	VIENNA		FP-49	P-89	C.CLAMP RU-488
	VIENNA S.		FP-49	P-89	C.CLAMP RU-488
	BERNA		FP-49	P-89	C.CLAMP RU-488

					
RUKO	RU-14D	SARATOGA	FP-49	P-89	C.CLAMP RU-488
		VIENNA	FP-49	P-89	C.CLAMP RU-488
		VIENNA S.	FP-49	P-89	C.CLAMP RU-488
		BERNA	FP-49	P-89	C.CLAMP RU-488
	RU-5D	SARATOGA	FP-49	P-89	C.CLAMP RU-488
		VIENNA	FP-49	P-89	C.CLAMP RU-488
		VIENNA S.	FP-49	P-89	C.CLAMP RU-488
		BERNA	FP-49	P-89	C.CLAMP RU-488
	RU-5I	SARATOGA	FP-49	P-89	C.CLAMP RU-488
		VIENNA	FP-49	P-89	C.CLAMP RU-488
		VIENNA S.	FP-49	P-89	C.CLAMP RU-488
		BERNA	FP-49	P-89	C.CLAMP RU-488
	RU-6I	SARATOGA	FP-49	P-89	C.CLAMP RU-488
		VIENNA	FP-49	P-89	C.CLAMP RU-488
		VIENNA S.	FP-49	P-89	C.CLAMP RU-488
		BERNA	FP-49	P-89	C.CLAMP RU-488
	RU-9D	SARATOGA	FP-49	P-89	C.CLAMP RU-488
		VIENNA	FP-49	P-89	C.CLAMP RU-488
		VIENNA S.	FP-49	P-89	C.CLAMP RU-488
		BERNA	FP-49	P-89	C.CLAMP RU-488
RU-9I	SARATOGA	FP-49	P-89	C.CLAMP RU-488	
	VIENNA	FP-49	P-89	C.CLAMP RU-488	
	VIENNA S.	FP-49	P-89	C.CLAMP RU-488	
	BERNA	FP-49	P-89	C.CLAMP RU-488	
SIMPLEX	SIX-3P	SARATOGA			AD-SIX
		VIENNA			AD-SIX
		VIENNA S.			AD-SIX
		BERNA			AD-SIX
		ECCO			AD-SIX

					
SIMPLEX	SIX-3P	EPLUS			AD-SIX
		EAUTO			AD-SIX
SOFER	SOF-1	SARATOGA			M-SOF
		VIENNA			M-SOF
		VIENNA S.			M-SOF
		BERNA			M-SOF
		ECCO			M-2L-S
		EPLUS			M-2L-S
	SOF-2	SARATOGA			M-SOF
		VIENNA			M-SOF
		VIENNA S.			M-SOF
		BERNA			M-SOF
TESA	TE-8I	SARATOGA	FP-49	P-89	C.CLAMP TE-476
		VIENNA	FP-49	P-89	C.CLAMP TE-476
		VIENNA S.	FP-49	P-89	C.CLAMP TE-476
		BERNA	FP-49	P-89	C.CLAMP TE-476
	TE-23	SARATOGA	FP-49	P-89	C.CLAMP TE-476
		VIENNA	FP-49	P-89	C.CLAMP TE-476
		VIENNA S.	FP-49	P-89	C.CLAMP TE-476
	TE-28	SARATOGA	FP-49	P-89	C.CLAMP TE-476
		VIENNA	FP-49	P-89	C.CLAMP TE-476
		VIENNA S.	FP-49	P-89	C.CLAMP TE-476

LLAVES ORIGINALES

JATORRIZKO GILTZAK

ORIGINAL KEYS

CLES ORIGINALES

ORIGINALSCHLÜSSEL



LLAVES PLANAS

GILTZA LAUAK





CYLINDER KEYS

CLES PLATES

ZYLINDERSCHLÜSSEL

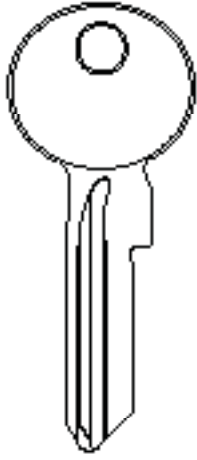
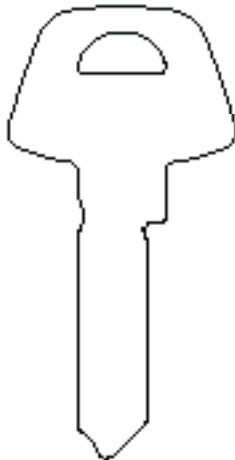
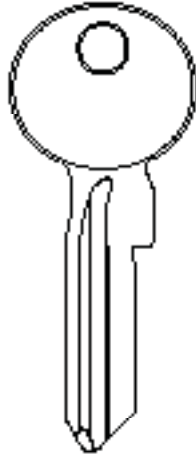
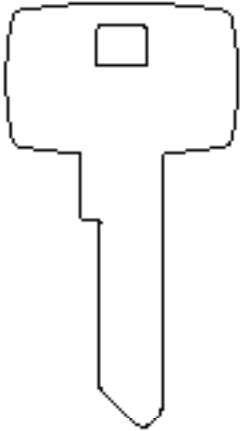
THE KEY TO EXCELLENCE

GLOBALLY UNLOCKING MILLIONS OF DOORS DAILY

ABUS	ASSA	CISA	DOM-DORMA
			
 ABUS XP	 012	 CISA XP	 R38 ORIGINAL

MÁQUINAS DUPLICADORAS

MAKINA MEKANIKOAK
KEY CUTTING MACHINES
MACHINES A REPRODUIRE
SCHLÜSSELKOPIERMASCHINEN



PARA LLAVES DE GORJA

GORJA-GILTZETARAKO

FOR BIT KEYS

POUR CLES A GORGES

FÜR DOPPELBARTSCHLÜSSEL

THE KEY TO EXCELLENCE
GLOBALLY UNLOCKING MILLIONS OF DOORS DAILY

SENA

La SENNA es la máquina duplicadora de JMA para llaves de gorja de simple y doble paletón, frontales y ranuras verticales, todo ello con un único carro. Dispone de un palpador (intercambiable) con ajuste micrométrico para su ajuste preciso. Utilizando una misma palanca se realiza los movimientos X e Y del carro, el cual está guiado por patines con rodillos.

The SENNA is the JMA duplicating machine for bit keys with single and double bits, frontal and vertical channel keys, all on the same carriage. It has a tracer (interchangeable) with micrometric adjustment for precision using the same lever it makes X and Y movements of the carriage, which is guided by bearings on rollers.



SARATOGA

Máquina duplicadora mixta de llaves planas, cruciformes, y por otro lado gorja de un paletón y doble paletón, frontales y especiales, pudiendo duplicar otros modelos de llaves con sus carros opcionales como regata, FORD®, ABLOY®. La Sataroga es una máquina robusta, sólida y fiable. Estas características y su versatilidad hacen de ella una máquina indispensable en cualquier punto de duplicado.

Mixed duplicating machine for flat keys, cruciform keys, and also for single and double bit keys, frontal and special keys, being able to duplicate other models of keys with its optional carriages like channel, FORD® and ABLOY® keys. The Sataroga is a strong, solid and reliable machine. These characteristics and its versatility have made it a necessary machine for any duplicating point.



VOLGA BIT

VOLGA BIT es el último modelo de máquinas JMA para el duplicado de llaves de gorja. En un tamaño compacto incorpora todos los elementos necesarios para duplicar con total precisión una gran variedad de llaves de gorja. Su principal novedad es la incorporación de un sistema de mordazas en dos alturas, con el que podrá duplicar llaves de cualquier longitud. Asimismo, las mordazas cuentan con amarres específicos para sujetar la punta de las llaves tipo "macho", y contrapuntos para el duplicado de las llaves "hembra" y llaves "macho" cortas.

VOLGA BIT is the latest model of JMA machines for the cutting of mortice keys. In a compact size it incorporates all the necessary elements for cutting a wide variety of mortice keys with total precision. Its main novelty is the incorporation of a two-height clamp system, with which you can cut keys of any length. Likewise, the clamps have specific fastenings to hold the tip of the "male" type keys, and counterpoints for the cutting of the "female" keys and short "male" keys.



LLAVES DE GORJA

BIT KEYS

ECCO BIT

Máquina económica semiautomática para el duplicado de llaves de gorja, de un paletón y de doble paletón, frontales y especiales. La máquina se convierte en muy versátil gracias a sus diferentes carros opcionales que te permiten duplicar llaves tipo Abloy (ABL-E), Ford (FD-E) y regata (RG-E).

Semiautomatic versatile machine for bit keys, single and double bit keys, frontal and special keys. A versatile machine with different optional carriages to allow the duplication of Abloy keys (ABL-E), Ford keys (FD-E) and regata Keys (RG-E).



ECCO RG

Máquina semiautomática para llaves de gorja de tipo regata, dispone además de otros carros opcionales para llaves de gorja de un paletón y doble paletón (BIT-E) llaves Abloy (ABL-E) y Ford (FD-E).

Special machine for Regata keys. In addition, this machine has optional carriages for BIT keys (BIT-E), Abloy Keys (ABL-E) and Ford (FD-E).



ECCO FORD

Máquina semiautomática para llaves de gorja de tipo regata. Máquina especial para el duplicado a código de llaves FO-6.P. Además, esta máquina dispone de carros opcionales para el duplicado de llaves de gorja (BIT-E), Abloy (ABL-E) y Regata (RG-E).

A Machine specifically designed for the duplication of Ford FO-6.P keys to code. In addition, this machine has optional carriages for BIT keys (BIT-E), Abloy (ABL-E) and Race (RG-E).



ECCO ABLOY

Máquina especial para el duplicado de llaves denominadas tipo Abloy. Además, esta máquina dispone de carros opcionales para el duplicado de llaves de gorja (BIT-E), Ford (FD-E) y Regata (RG-E).

Special machine for Abloy Keys. In addition, this machine has optional carriages for BIT keys (BIT-E), Ford (FD-E) and Regata (RG-E).





FRESAS / MILLING CUTTERS

CODE	AXBXC	Cor. Lateral Side Cut	PALP.	PARA-FOR	MAT
FP-7	63x1,25x16	X	PP-7	ECCO BIT-DETROIT	HSS
FP-8	63x1,4x16	X	PP-8	ECCO BIT-DETROIT	HSS
FP-9	63x1x16		PP-9	ECCO BIT	HSS
FP-10	63x2,4x16		PP-10	ECCO FORD-ECCO ABLOY-PASADENA-NEBRASCA	HSS
FP-17	80x1,25x16	X		SARATOGA-YAKARTA-TITAN BIT	HSS
FP-18	80x1,25x22	X		ATLANTA-TOPEKA	HSS
FP-19	80x1,4x16	X		SARATOGA-YAKARTA-TITAN BIT - DAKOTA G	HSS
FP-20	80x1,4x22	X		ATLANTA-TOPEKA	HSS
FP-21	80x1,5x22	X		DUPLEX-ATLANTA-TOPEKA-KANSAS	HSS
FP-21W	80x1,5x22	X		DUPLEX-ATLANTA-TOPEKA-KANSAS	W
FP-22	80x1x16			SARATOGA-DAKOTA G-TITAN BIT	HSS
FP-23	80x1x22	X		DUPLEX-ATLANTA-TOPEKA	HSS
FP-26	80x1,5x16			SARATOGA-YAKARTA-DAKOTA-G-SENNA	HSS
FP-26W	80x1,5x16			SARATOGA-YAKARTA-DAKOTA-G-SENNA	W
FP-27W	70x2,4x16			AVANTCODE	W
FP-28W	70x1,7x16			AVANTCODE	W
FP-31	80x1,6x16			SARATOGA-DAKOTA G-TITAN BIT	HSS
FP-33W	70x1,25x16			AVANTCODE	W

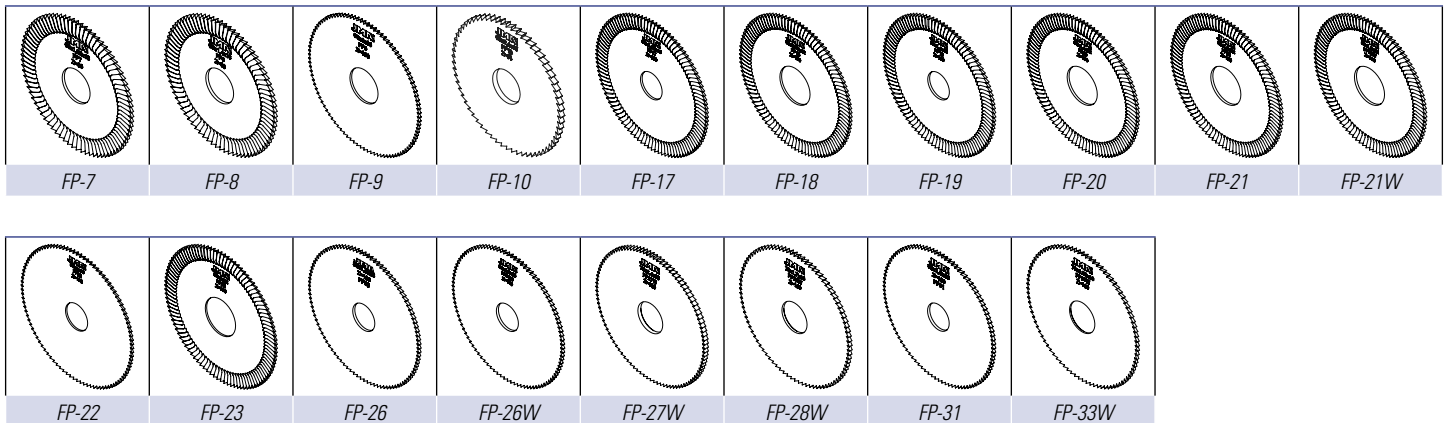
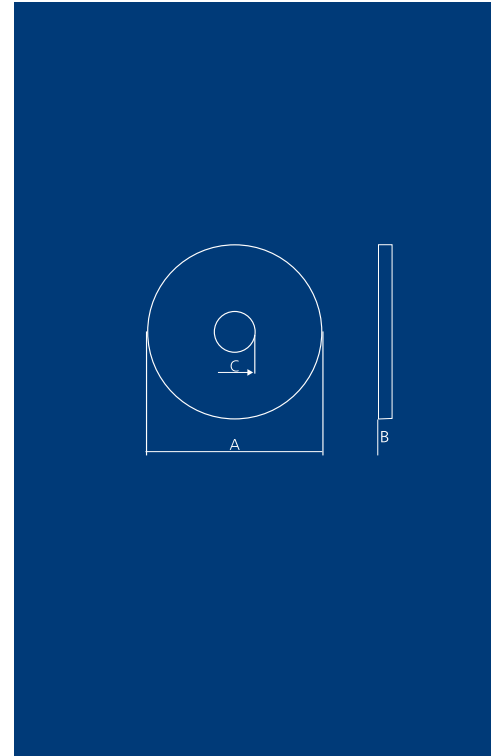

SIMBOLOGÍA / SYMBOLS

W

Fresa de metal duro
Metal gogorreko fresa
Hard metal cutters
Fraise en métal dur
Hartmetallfräse



Espesor
Lodiera
Thickness
Épaisseur
Stärke



Diámetro interior
Barnealdeko diametroa
Internal diameter
Alésage
Innen-Durchmesser

HSS

Acero extra rápido
Altzairu estra azkarra
High-speed steel
Acier extra rapide
Extraschneller Stahl



Diámetro externo
Kanpoaldeko diametroa
External diameter
Diamètre extérieur
Aussen-Durchmesser



PALPADORES / TRACERS

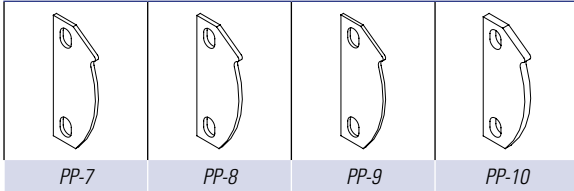

PP-7

PP-8

PP-9

PP-10



ADAPTADORES / ADAPTERS

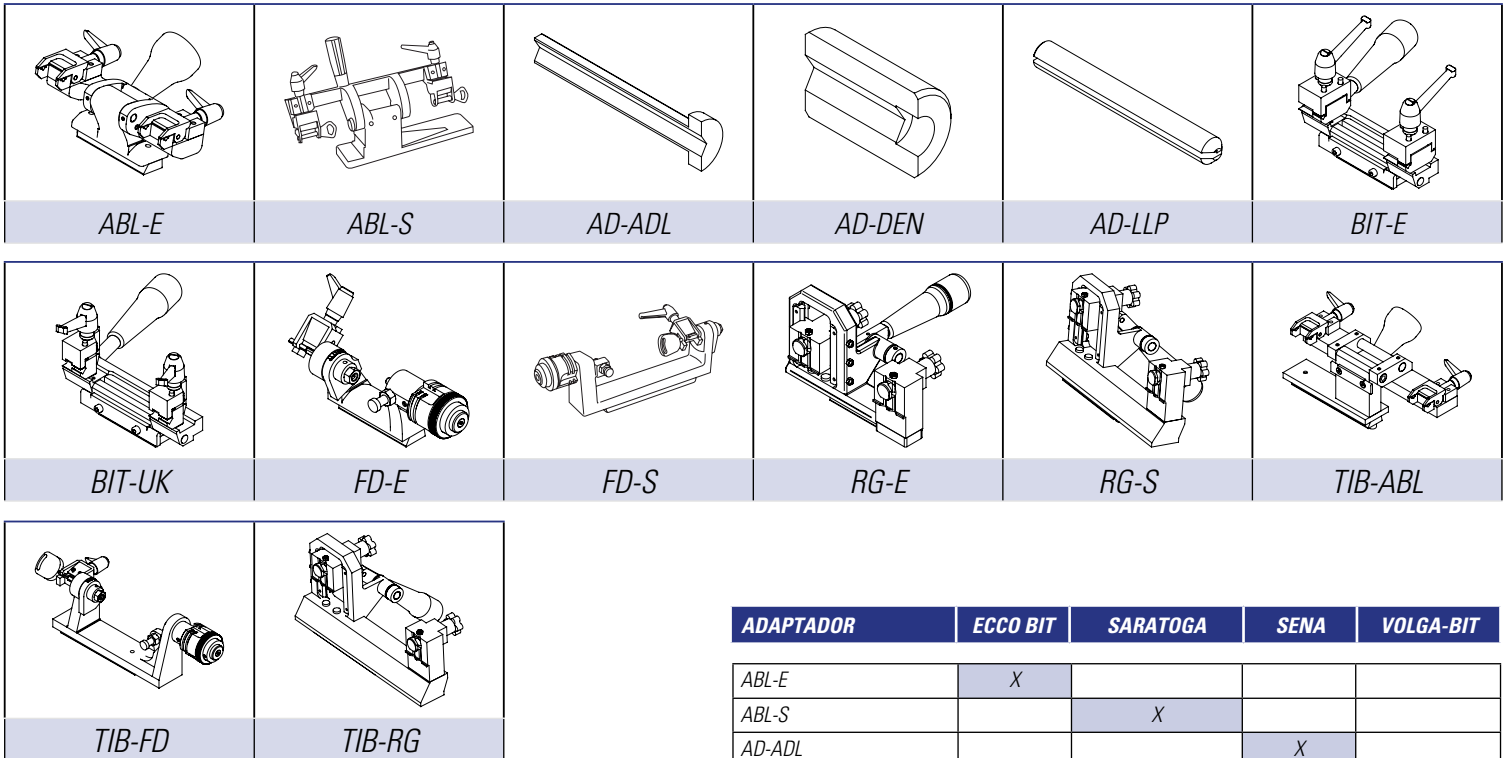

ABL-E

ABL-S

AD-ADL

AD-DEN

AD-LLP

BIT-E

BIT-UK

FD-E

FD-S

RG-E

RG-S

TIB-ABL

TIB-FD

TIB-RG

ADAPTADOR	ECCO BIT	SARATOGA	SENA	VOLGA-BIT
ABL-E	X			
ABL-S		X		
AD-ADL			X	
AD-DEN			X	
AD-LLP		X	X	X
BIT-E	X			
BIT-UK	X			
FD-E	X			
FD-S		X		
RG-E	X			
RG-S		X		
TIB-ABL				X
TIB-FD				X
TIB-RG				X

FICHA ESPECIALISTA

ESPEZIALISTAREN FITXA

SPECIALIST FILE

FICHE SPÉCIALISÉE

DATENBLATT FÜR FACHLEUTE

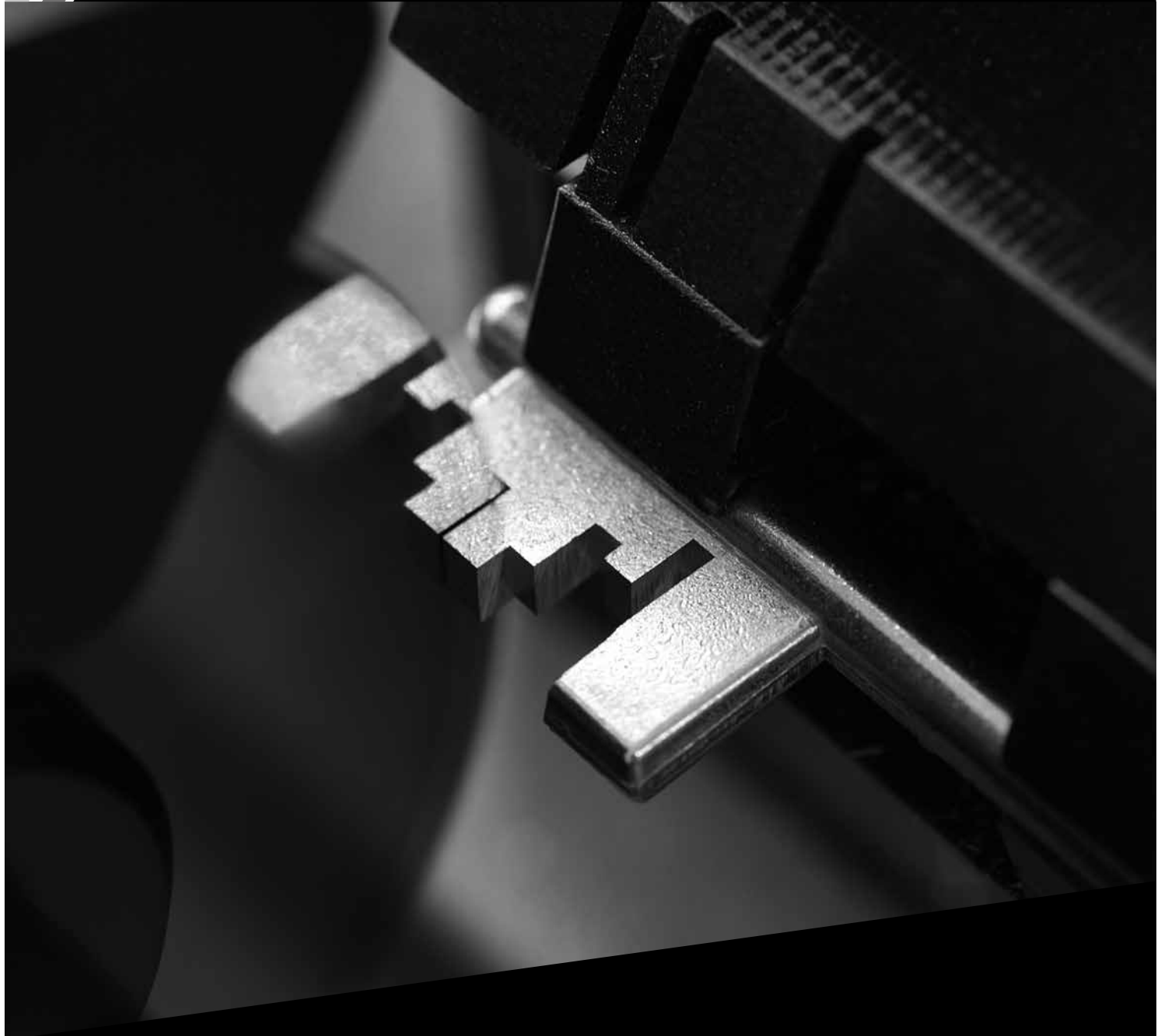

PARA LLAVES DE GORJA

GILTZA LAUETARAKO







FOR BIT KEYS



POUR CLES À GORGES

FÜR DOPPELBARTSCHLÜSSEL

THE KEY TO EXCELLENCE





GLOBALLY UNLOCKING MILLIONS OF DOORS DAILY





					
ABLOY	ABL-1	SARATOGA			ABL-S
		TITANBIT			TIB-ABL
		EABLOY			ABL-E
	ABL-2	SARATOGA			ABL-S
		TITANBIT			TIB-ABL
		EABLOY			ABL-E
	ABL-3	SARATOGA			ABL-S
		TITANBIT			TIB-ABL
		EABLOY			ABL-E
	ABL-3D	SARATOGA			ABL-S
		TITANBIT			TIB-ABL
		EABLOY			ABL-E
	ABL-4	SARATOGA			ABL-S
		TITANBIT			TIB-ABL
		EABLOY			ABL-E
ABL-7	SARATOGA			ABL-S	
	TITANBIT			TIB-ABL	
	EABLOY			ABL-E	
ABUS	ABU-29P	SARATOGA			ABL-S
		TITANBIT			TIB-ABL
		EABLOY			ABL-E
	ABU-3	SARATOGA			ABL-S
		TITANBIT			TIB-ABL
		EABLOY			ABL-E
ADPLE	ADPLE-11	SENA			AD-ADL
	ADPLE-22	SENA			AD-ADL
	ADPLE-33	SENA			AD-ADL

						
ADPLE	ADPLE-44	SENA			AD-ADL	
	ADPLE-55	SENA			AD-ADL	
ANCHOR	ANC-2	SARATOGA			ABL-S	
		TITANBIT			TIB-ABL	
		EABLOY			ABL-E	
ARCU	ARC-17DP	EBIT			BIT-E	
	ARC-17DP	EBIT			BIT-E	
ARFE	ARFE-2	SENA			AD-LLP	
		SARATOGA			AD-LLP	
		TITANBIT			AD-LLP	
		EBIT			BIT-E	
DENNY	DEN-1	SENA			AD-DEN	
	DEN-2	SENA			AD-DEN	
DIEBOLD	DIE-1	SENA			AD-LLP	
		EBIT			BIT-E	
FORD	FO-22P	SARATOGA				
		EBIT			BIT-UK	
	FO-4P	SARATOGA				
		EBIT			BIT-UK	
	FO-6P	SARATOGA			FD-S	
FORD	FO-6P	TITANBIT			TIB-FD	
		EFORD			FD-E	
HECTOR	HEC-1	SENA			AD-LLP	
		SARATOGA			AD-LLP	
		TITANBIT			AD-LLP	
		EBIT			BIT-E	
IFAM	IF-3P	SARATOGA			ABL-S	

LLAVES DE GORJA

BIT KEYS

					
		TITANBIT			TIB-ABL
		EABLOY			ABL-E
MILES	MIL-1	SENA			
		SARATOGA			AD-LLP
		TITANBIT			AD-LLP
		EBIT			BIT-E
	MIL-2	SENA			AD-LLP
		SARATOGA			AD-LLP
		TITANBIT			AD-LLP
		EBIT			BIT-E
PENZMASH	PEN-2	SENA			AD-LLP
		SARATOGA			AD-LLP
		TITANBIT			AD-LLP
		EBIT			BIT-E
RIL	26-M	SENA			AD-LLP
		SARATOGA			AD-LLP
		TITANBIT			AD-LLP
		EBIT			BIT-E
SERRETA	7-S	SENA			AD-LLP
		SARATOGA			AD-LLP
		TITANBIT			AD-LLP
SERRETA	7-S	EBIT			BIT-E
SOLER	SOL-1	SENA			AD-LLP
		SARATOGA			AD-LLP
		TITANBIT			AD-LLP
		EBIT			BIT-E
TIBBE	JAU-1P	SARATOGA			FD-S

					
		TITANBIT			TIB-FD
		EFORD			FD-E
	JAU-2P	SARATOGA			FD-S
		TITANBIT			TIB-FD
		EFORD			FD-E
TRUPER	TRU-7	SARATOGA			ABL-S
		TITANBIT			TIB-ABL
		EABLOY			ABL-E
	TRU-8P	SARATOGA			ABL-S
TITANBIT				TIB-ABL	
EABLOY				ABL-E	
URKO	URKO-4	SENA			AD-LLP
		SARATOGA			AD-LLP
		TITANBIT			AD-LLP
		EBIT			BIT-E
YALE	YA-30	SENA			AD-LLP
		SARATOGA			AD-LLP
		TITANBIT			AD-LLP
		EBIT			BIT-E

JMA SPAIN

JMA ALEJANDRO ALTUNA, S.L.U.
Tel +34 943 79 30 00
Fax +34 943 79 72 43
Bidekurtzeta, 6 P.O.Box - Apdo. 70
20500 Arrasate - Mondragón
Gipuzkoa – SPAIN
www.jma.es
jma@jma.es

JMA FRANCE

JMA FRANCE SAS
Tel +33 01 39 22 42 10
Fax +33 01 39 22 42 11
Technoparc
13, rue Edouard Jeanneret
F- 78306 Poissy Cedex
www.jmafrance.fr
service.commercial@jmafrance.fr

JMA POLSKA

JMA POLSKA Sp. z o.o.
Tel +48 42 635 12 80
Fax +48 42 635 12 85
91- 342 Łódź, ul. Zbąszyńska 3
www.jmapolska.pl
biuro@jmapolska.pl

JMA PORTUGAL

ALTUNA PORTUGAL
COMERCIO DE CHAVES UNIPessoal, LDA.
Tel +351 219 947 470
Fax +351 219 947 471
Rua de Goa N°22
2690-356 Santa Iria de Azoia
www.jmaportugal.com
comercial@jmaportugal.com

JMA UK

SKS LTD
Tel +44 144 229 1400
Fax +44 144 286 3683
Unit 2, Canalside Northbridge Road
Berkhamsted
Herts HP4 1EG
www.jmakeys.co.uk
sales@sks.co.uk

JMA MAROC

JMA MAROC S.A.R.L.
Tel +0520 150 535
Fax +0520 150 536
83,85 Bd Oued ZIZ, El Oulfa
Casablanca
www.jma.ma
jma@jma.ma

JMA INDIA

JMA KEYS INDIA PVT. LTD
Tel +91 124 428 5450
Fax +91 124 428 5451
H-239 & H-240, Sushant Shopping Arcade
Sushant Lok-1, Block B
122002 Gurgaon (Haryana)
www.jmakeys.in
info@jmakeys.in

JMA MEXICO

LLAVES ALTUNA DE MEXICO S.A de C.V
Tel +52 33 3777 1600
Fax +52 33 3777 1609
Av. Aviación No. 5520
Col. San Juan de Ocotán
C.P. 45019 Zapopan, Jalisco
www.jma.com.mx
ventas@jma.com.mx

JMA PERU

JMA PERU S.A.C.
Tel +51 639 9300
Av. Los Paracas 130,
Urbanización Salamanca,
Distrito Ate, Lima
www.jma-peru.com
info@jma-peru.com

JMA USA

ALTUNA GROUP USA INC.
Tel +1 817 385 0515
Fax +1 817 385 4850
1513 Greenview Drive
75050 Grand Prairie
Texas
www.jmausa.com
info@jmausa.com

JMA ARGENTINA

JMA ARGENTINA S.A.
Tel +54 336 4 462 422
Fax +54 336 4 462 422
Av. Central Acero Argentino Oeste 678
Parque industrial COMIRSA
2900 San Nicolas (Prov. Buenos Aires)
www.jma.com.ar
info@jma.com.ar

JMA URUGUAY

JMA URUGUAY S.A.
Tel +598 2908 1175
Fax +598 2900 6681
Mercedes 1420
11100 Montevideo
www.jma.com.uy
info@jma.com.uy

JMA WORLDWIDE

ALTUNA GROUP HEADQUARTERS

Tel +34 943 79 30 00
Fax +34 943 79 72 43
Bidekurtzeta, 6 P.O.Box - Apdo. 70
20500 Arrasate - Mondragón
Gipuzkoa – SPAIN
www.altuna.com



Member Of
Altuna Group